

Luminosity @ LHC

How to measure cross sections ...

event rate

Cross section

$$N = L \times \sigma$$

Luminosity
(Machine parameter)

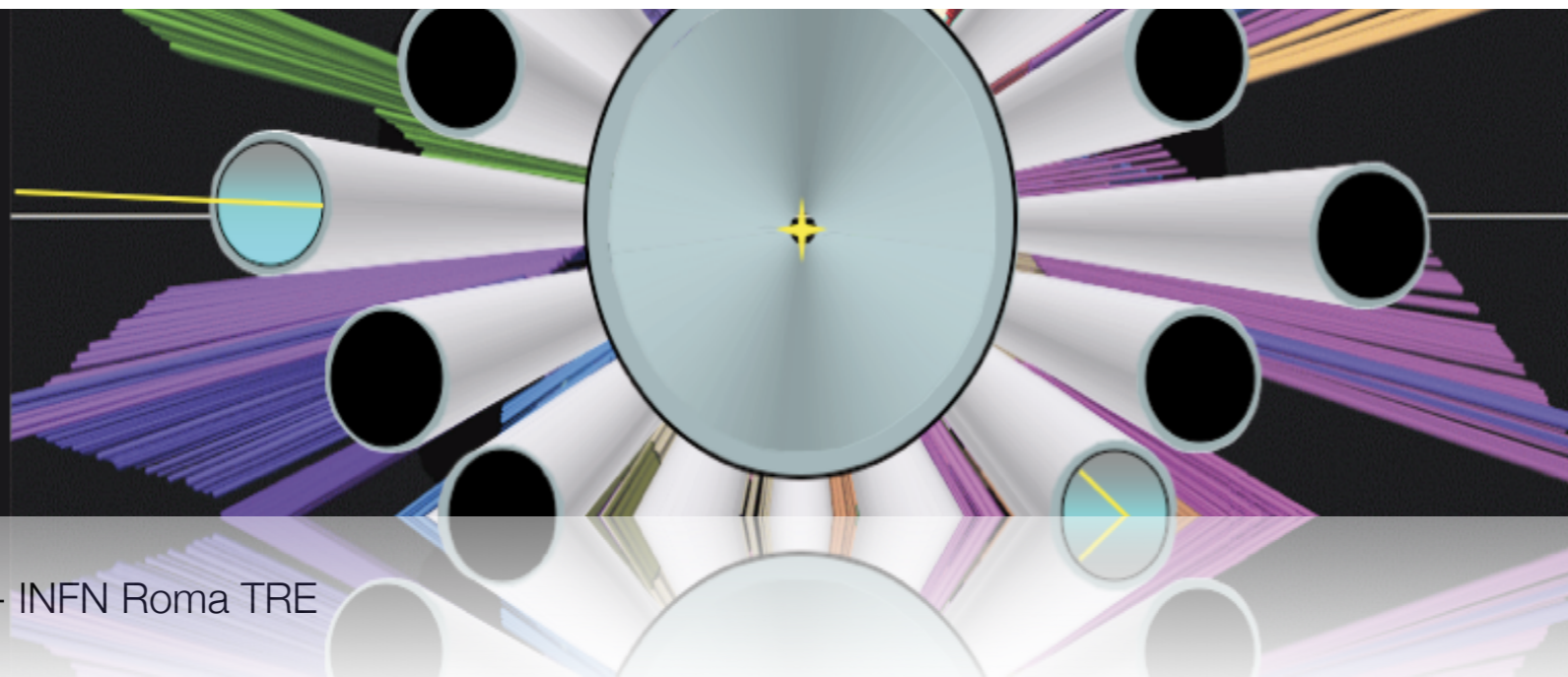

Luminosities at LHC in run-I/II

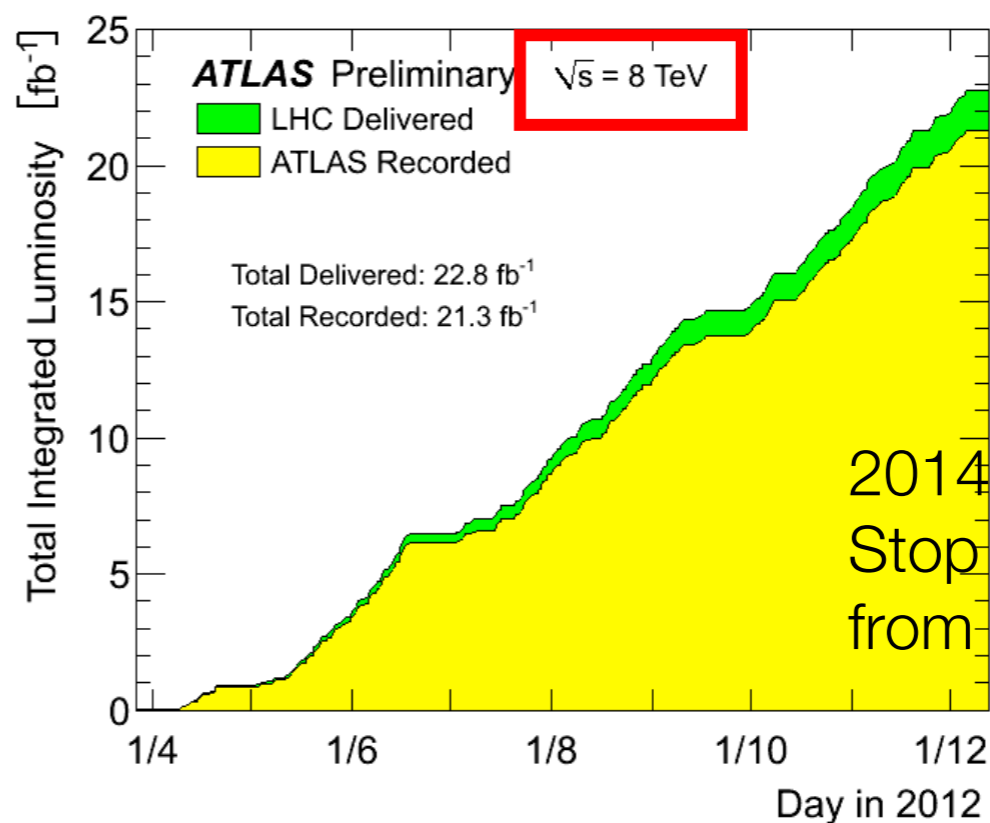
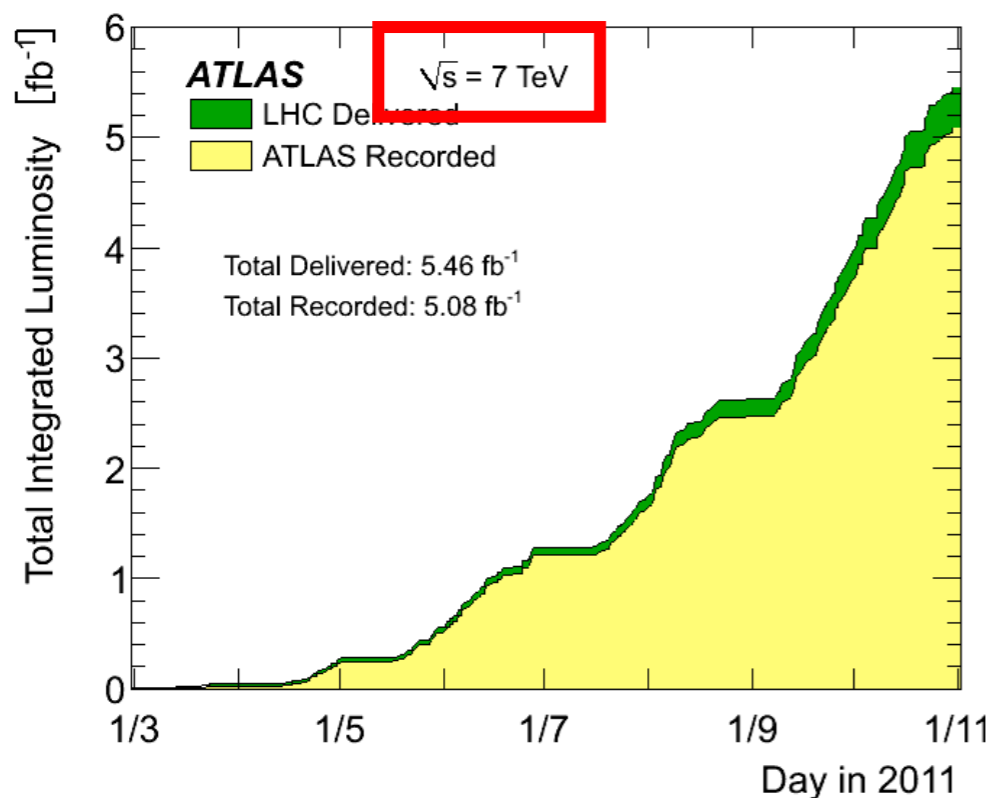

2014-2015 LHC Stop → \sqrt{s} goes from 7,8 to 13 TeV

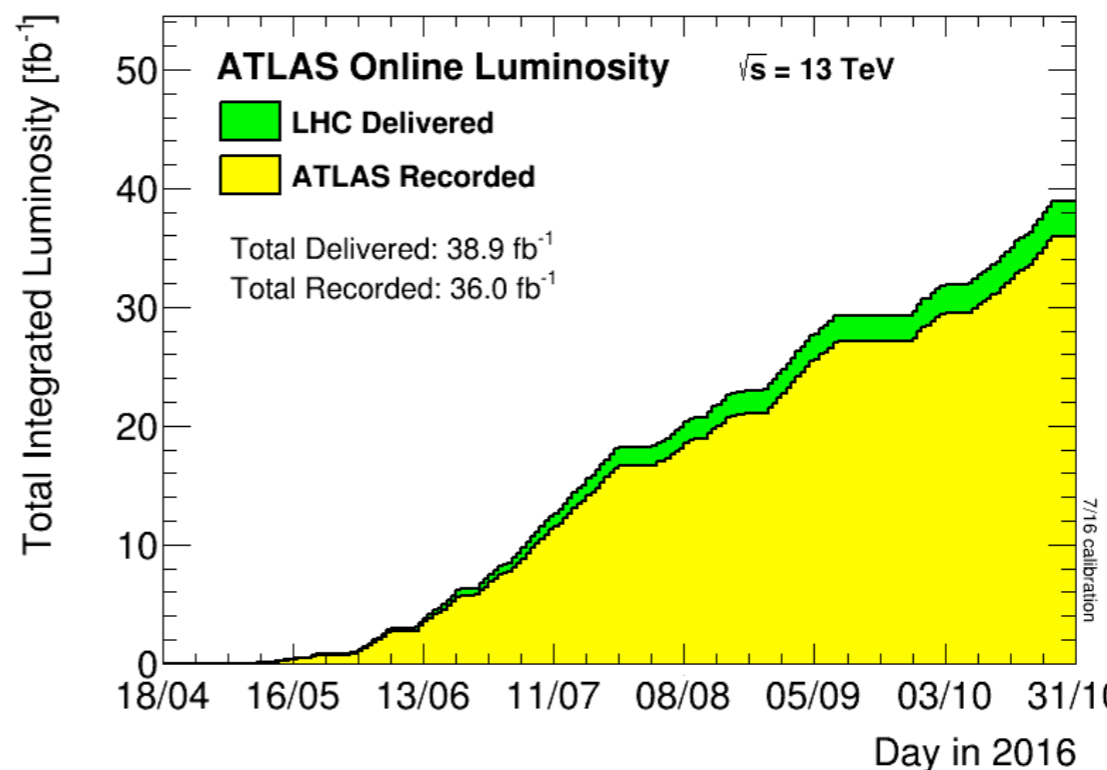
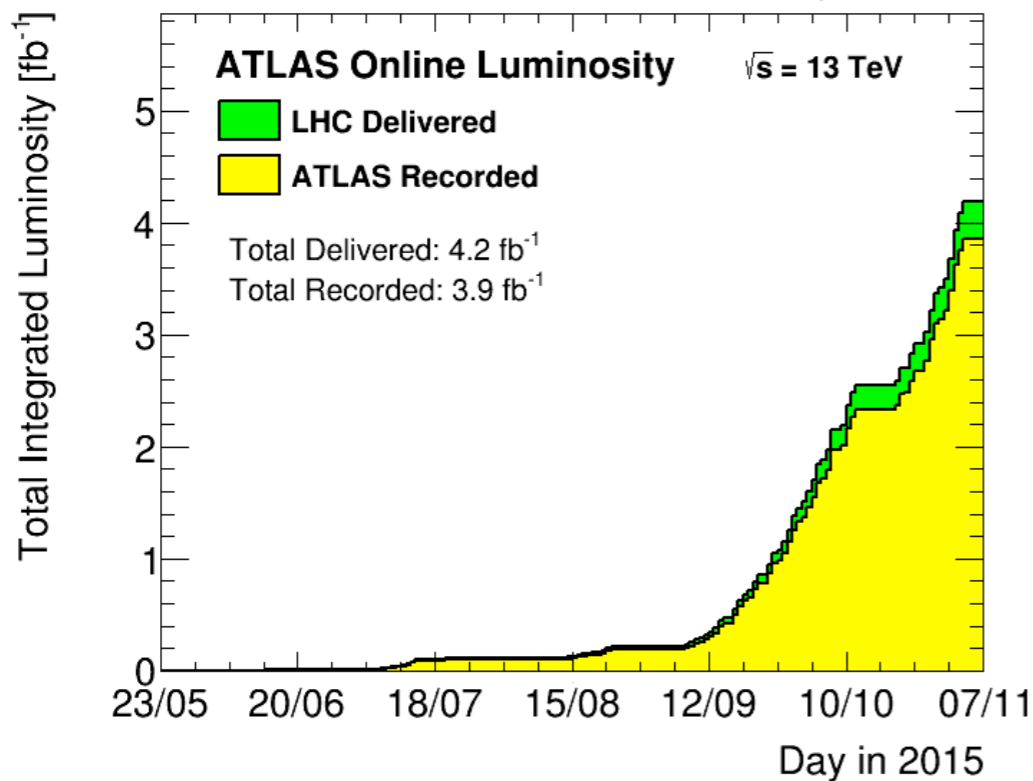

Multiple-Years Luminosity in ATLAS

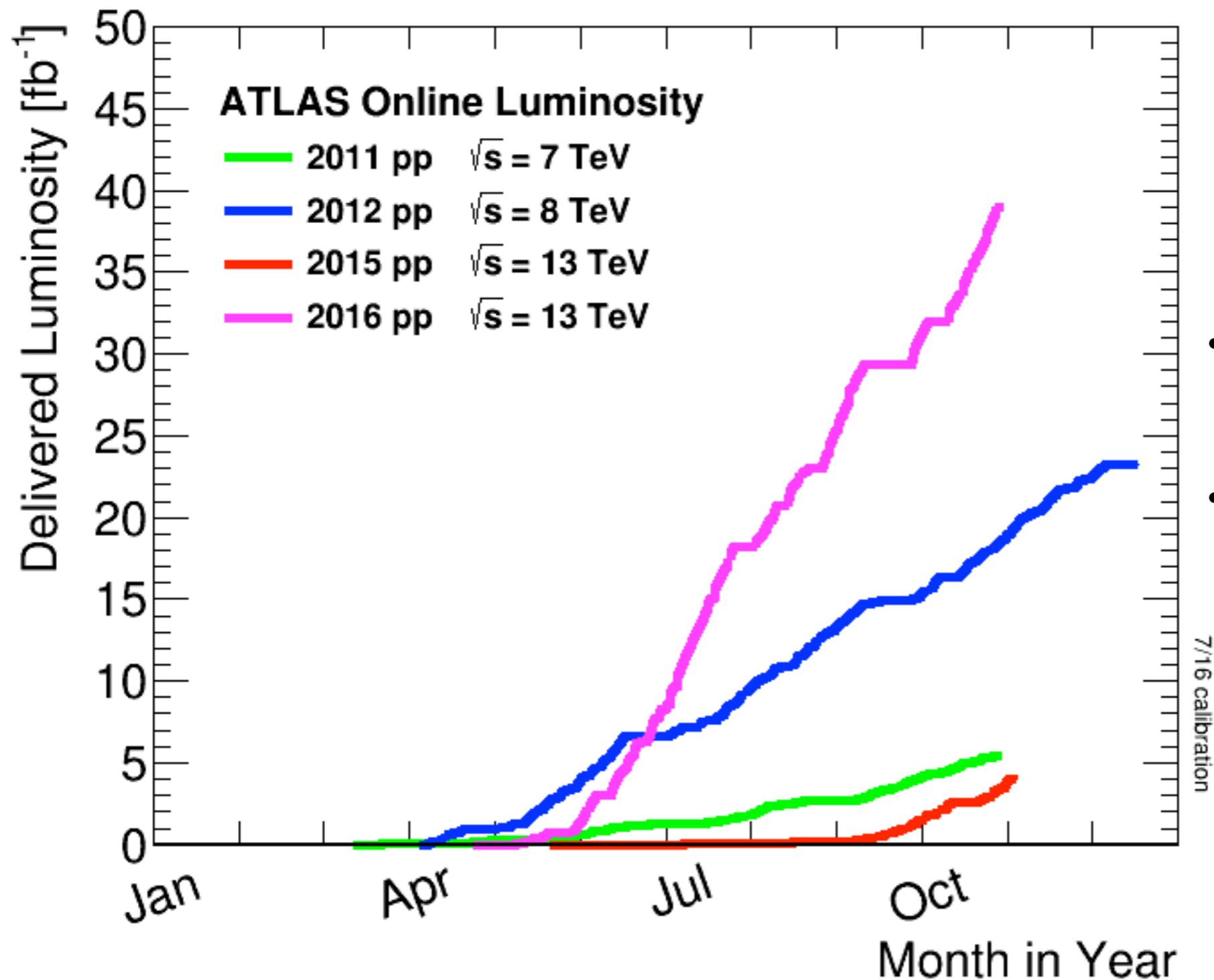

- Slope changes significantly and increases with year
- Summer run / winter stop

Cross Section & Luminosity

Number of observed events

just count ...

Background

measured from data or
calculated from theory

$$\sigma = \frac{N^{\text{obs}} - N^{\text{bkg}}}{\int \mathcal{L} dt \cdot \epsilon}$$

Luminosity

determined by accelerator,
triggers, ...

Efficiency

many factors, optimized
by experimentalist

How to measure luminosity

1. Direct bunch profile and intensity measurements

- Van der Meer scan (VdM) ALICE, ATLAS, CMS, LHCb
- Beam-Gas-Imaging (BGI) LHCb

2. Based on optical theorem

- Forward scattering at very low angles ATLAS with ALFA,
- Cross-calibration of luminosity detectors CMS with TOTEM
- Challenging, program ongoing

... and to monitor it with time

use of tracking detectors & calorimeters

Luminosity Determination @ LHC

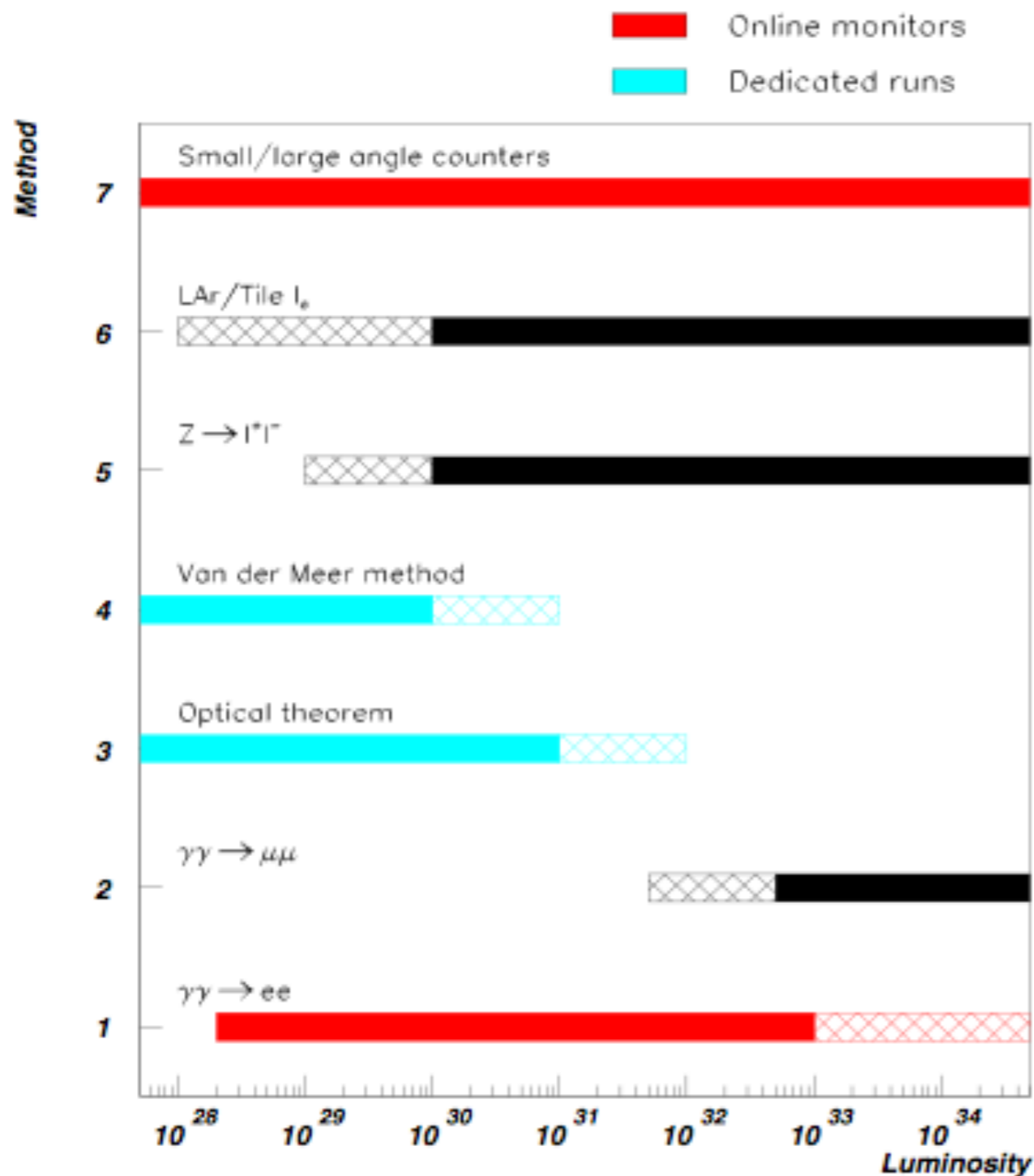

Methods as summarized in ATLAS TDR

[ATLAS Technical Design Report, Vol. I]

External material



Measurement of the luminosity at LHC

Gabriel Anders
CERN



On behalf of the ALICE, ATLAS, CMS and LHCb
collaborations

August 11th, 2014

Physics at LHC and beyond (Quy Nhon, Vietnam)

Luminosity Determination @ LHC (old slide)

Absolute Methods:

Determination from LHC parameters; van-der-Meer separation scans ...
Rate measurement for standard candle processes ...

LHC Examples:

Rate of $pp \rightarrow Z/W \rightarrow \ell\ell/\ell\nu$ [needs: electroweak cross sections]

Rate of $pp \rightarrow \gamma\gamma \rightarrow \mu\mu, ee$ [needs: QED & photon flux]

Optical theorem: $\sigma_{\text{tot}} \sim \text{Im } f(0)$ [needs: forward elastic and total inel. x-sec]

Elastic scattering in Coulomb region ...

Combination of the above ...

Accuracy: from 10%-
To today ~3%

Accuracy: 5-10%
[PDF knowledge, ...]

Accuracy: 1-5% ?
[TDR; needs forw. tagging]

[needs σ_{tot} ; needs forw. instrumentation]
Accuracy: 5-10%

Accuracy: 2-3%

TOTEM

Relative Methods:

Particle counting; using Cherenkov monitors [e.g. LUCID @ ATLAS]
[needs to be calibrated for absolute luminosity]

Aim: Luminosity accuracy of 2-3% ...

Cross Section & Luminosity

Colliders

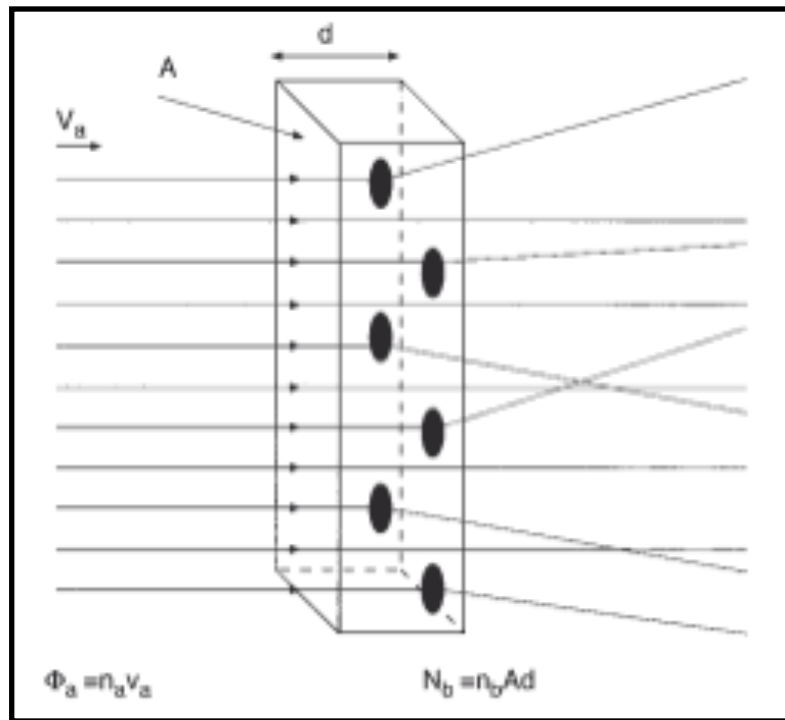

Instantaneous Luminosity

rate of events $\dot{N} \equiv L \cdot \sigma$

$$N = \sigma \cdot \underbrace{\int L dt}_{\text{integrated luminosity}} \quad \sigma = N/L$$

Collider experiment:

$$\Phi_a = \frac{\dot{N}_a}{A} = \frac{N_a \cdot n \cdot v/U}{A} = \frac{N_a \cdot n \cdot f}{A}$$

$$L = f \frac{n N_a N_b}{A} = f \frac{n N_a N_b}{4\pi\sigma_x\sigma_y}$$

$$\Phi_a = \frac{\dot{N}_a}{A} = n_a v_a$$

- Φ_a : flux
- n_a : density of particle beam
- v_a : velocity of beam particles

$$\dot{N} = \Phi_a \cdot N_b \cdot \sigma_b$$

- N : reaction rate
- N_b : target particles within beam area
- σ_a : effective area of single scattering center

$$L = \Phi_a \cdot N_b$$

- L : luminosity

LHC:

- $N_x \sim 10^{11}$
- $A \sim .0005 \text{ mm}^2$
- $n \sim 2800$
- $f \sim 11 \text{ kHz}$
- $L \sim 10^{34} \text{ cm}^{-2} \text{ s}^{-1}$

- N_a : number of particles per bunch (beam A)
- N_b : number of particles per bunch (beam B)
- U : circumference of ring
- n : number of bunches per beam
- v : velocity of beam particles
- f : revolution frequency
- A : beam cross-section
- σ_x : standard deviation of beam profile in x
- σ_y : standard deviation of beam profile in y

Van-der-Meer Separation Scan

Determine beam size ...

measuring size and shape of the interaction region by recording relative interaction rates as a function of transverse beam separation ...

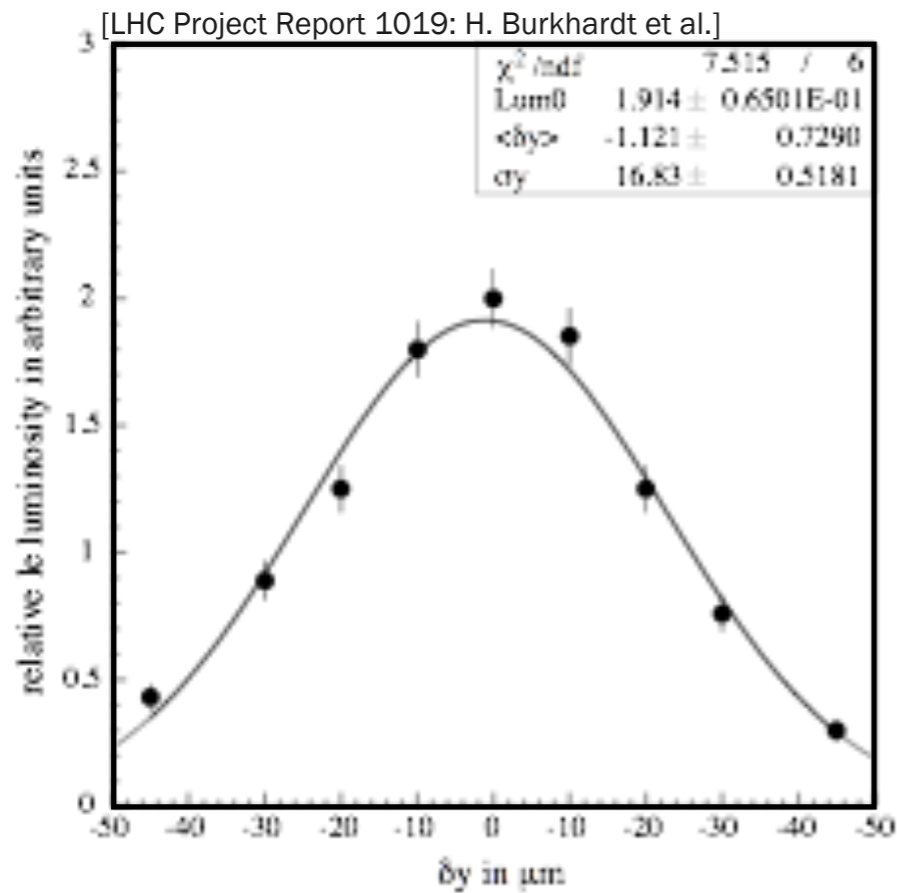
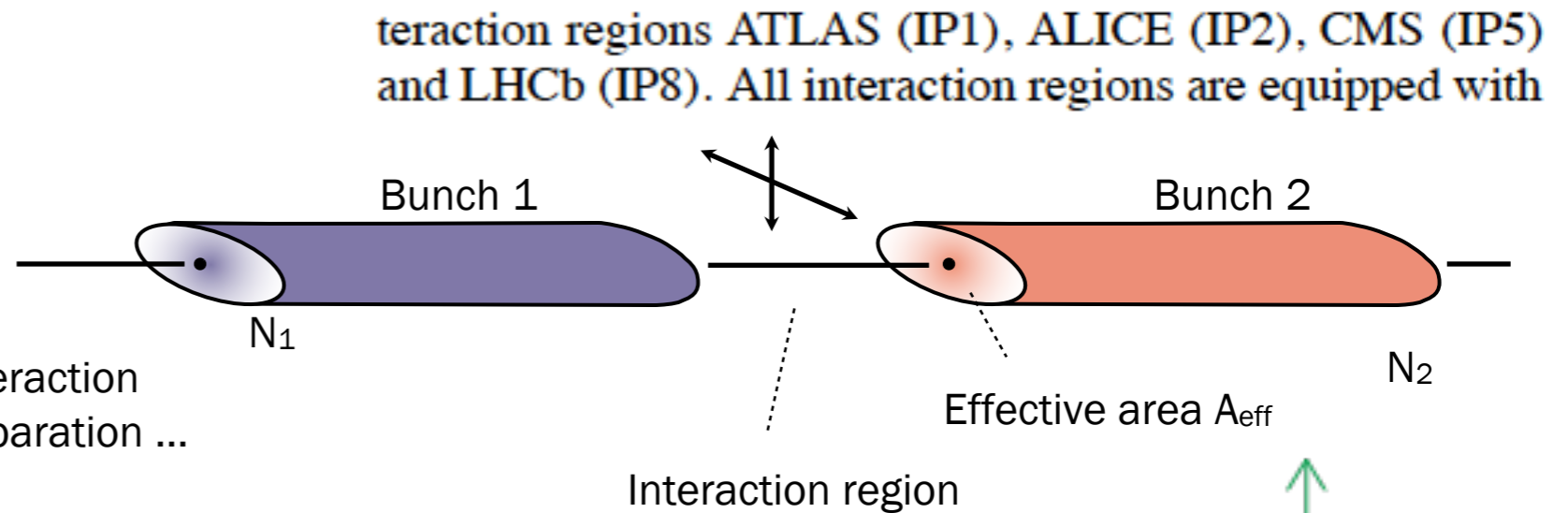

Rate

[IPAC 2010, S. White et al.]
[November 2009].

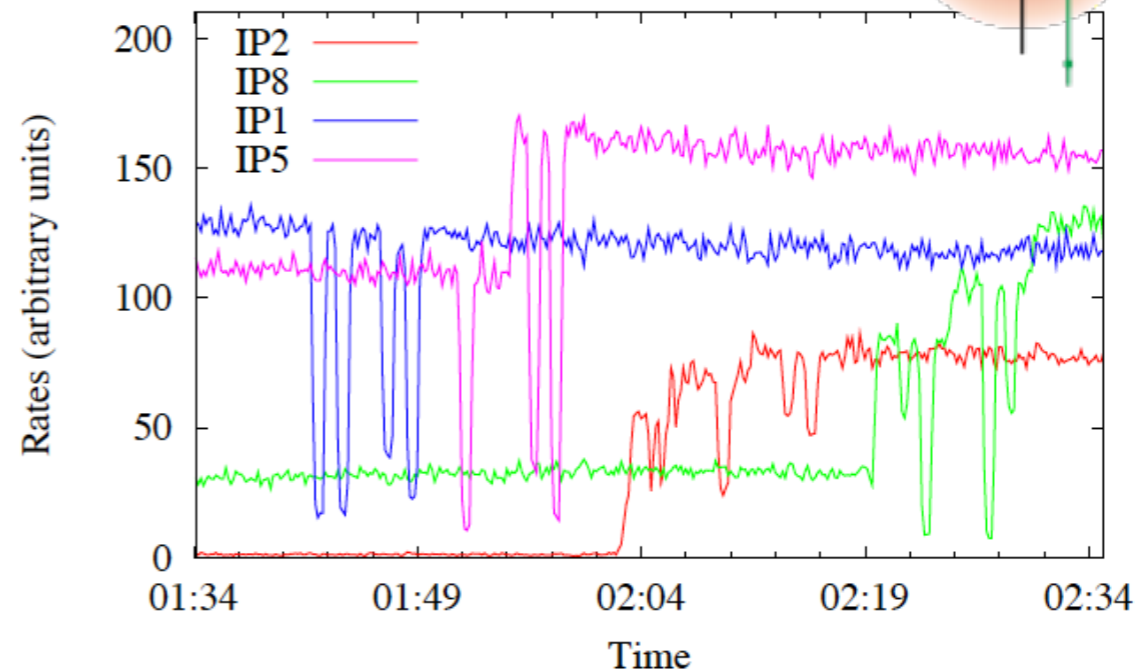

$$\frac{L}{L_0} = \exp \left[- \left(\frac{\delta_x}{2\sigma_x} \right)^2 - \left(\frac{\delta_y}{2\sigma_y} \right)^2 \right]$$

Figure 2: Optimization scans performed for squeezed optics in all IPs.

olliders

Shape of the beam : 1 g or 2 g?

$$\mathcal{L}_0 = \frac{N_1 N_2 f N_b}{2\pi \sqrt{(\sigma_{1x}^2 + \sigma_{2x}^2)(\sigma_{1y}^2 + \sigma_{2y}^2)}}$$

Factorizability

$$\sigma_u = \sqrt{\sigma_{1u}^2 + \sigma_{2u}^2} \text{ with } u = x, y :$$

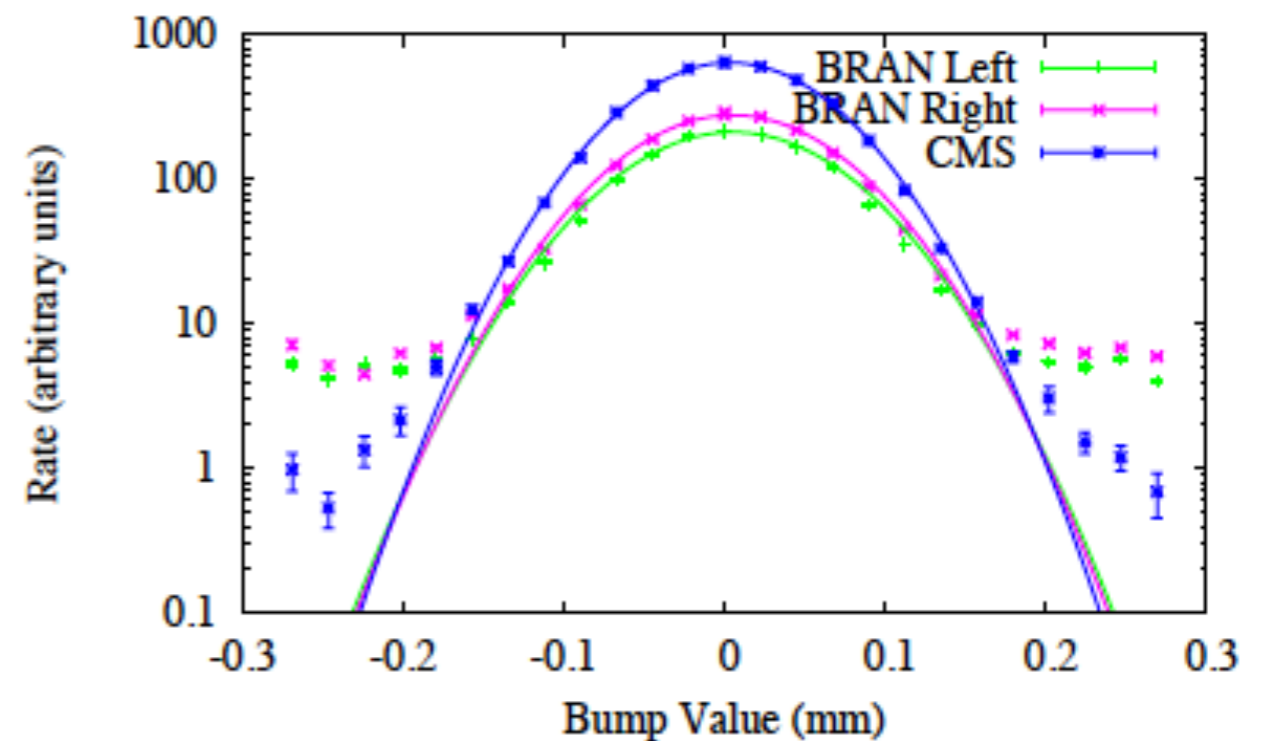
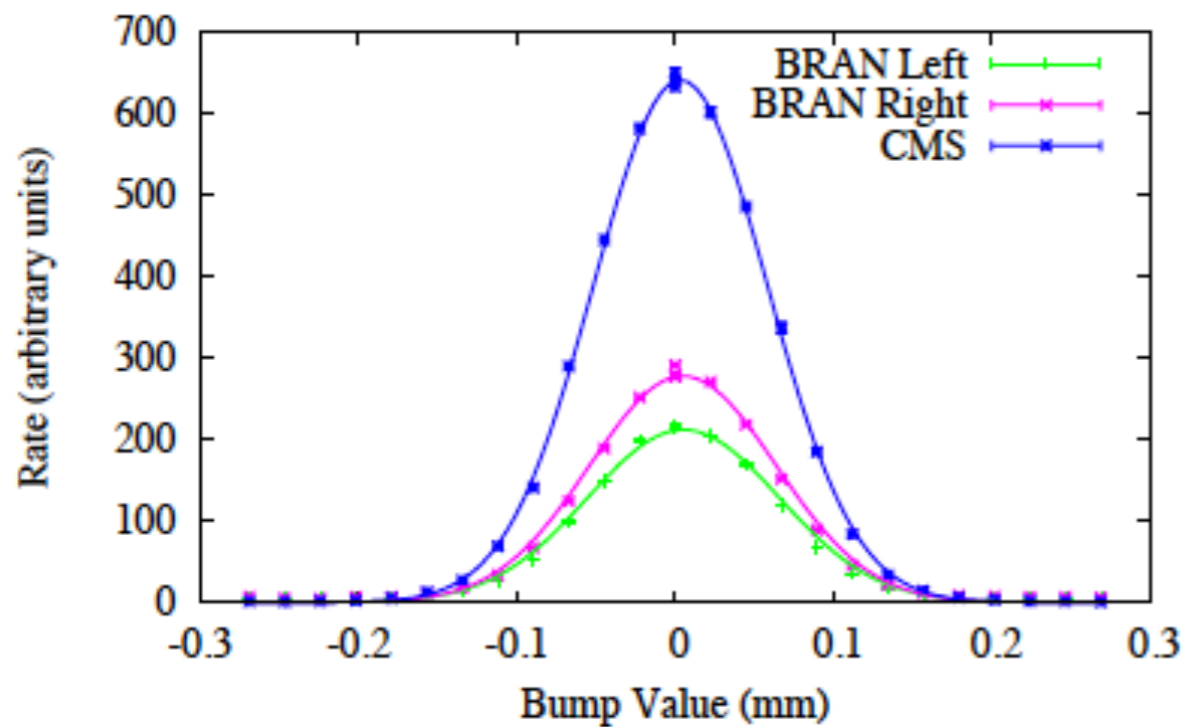
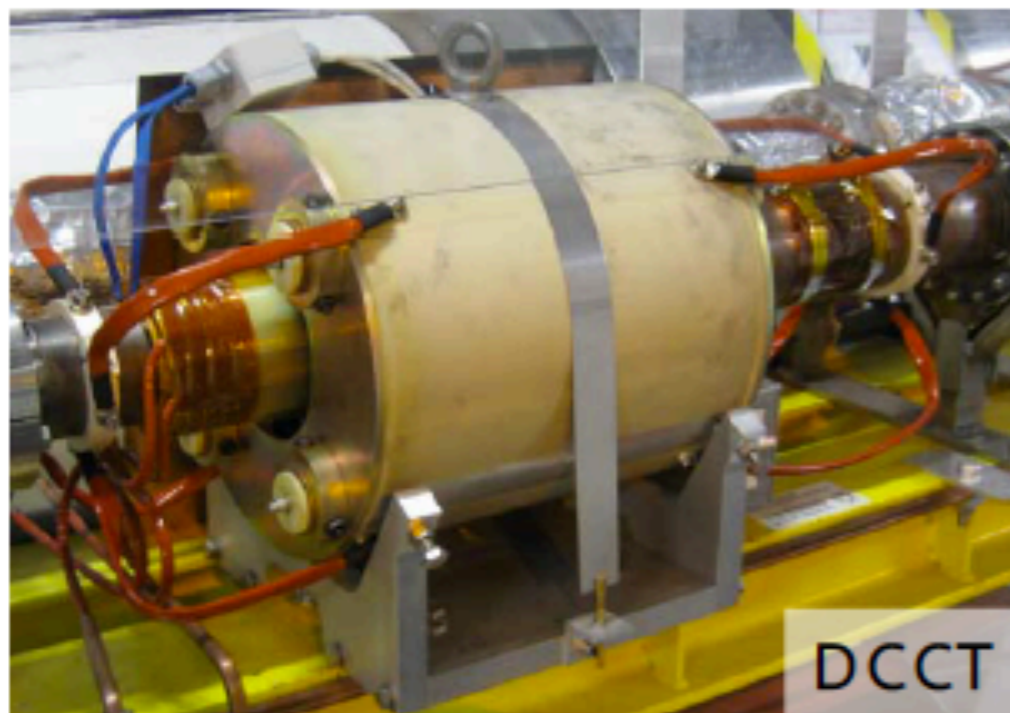

Figure 4: Same horizontal scan in IP5 shown in logarithmic scale with pure Gaussian fits.

Measuring beam populations

DC Current Transformer



- total current measurement with high accuracy
- two in each beam

Fast Beam Current Transformer

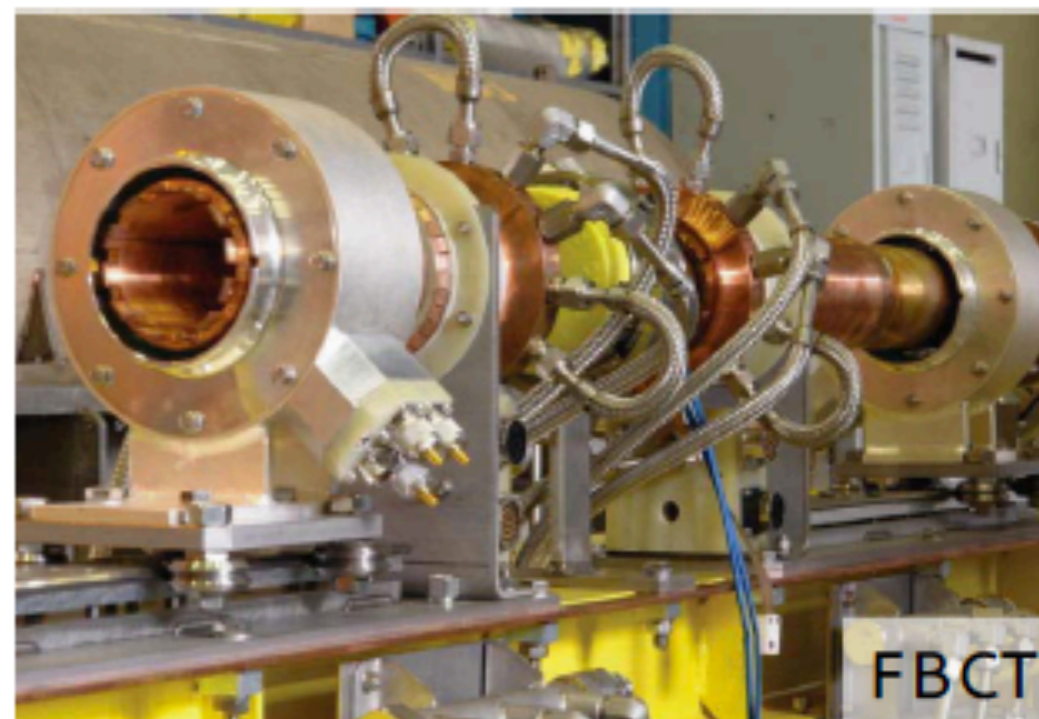

- bunch-by-bunch current measurement
- two in each beam

- Relative fraction of total current in each BCID from FBCT
- Normalization to overall current scale provided by DCCT

CERN-ATS-Note-2012-026
CERN-ATS-Note-2012-028
CERN-ATS-Note-2012-029

Kristof Kreuzfeldt, U. Gießen

15

... of the bunch structure...1

The LHC is operated at the radio frequency (RF) of about 400 MHz, which corresponds to **exactly 35640 RF bins** of about 2.5 ns length and equidistantly distributed over the ring circumference. These RF bins are conventionally numbered from 1 to 35640. Nominally, only one out of ten bins is filled with a bunch. By convention, these bins are numbered 1, 11, 21, 31, ... 35631, and they are each associated with a bunch slot **spanning 25 ns** and numbered from 1 to 3564. The slot, also called Bunch Crossing ID (BCID), is just a convenient index to discuss the LHC measurements in customary “40 MHz” parlance. For luminosity calibration measurements, it is important to remember that the base RF of the LHC is 400 MHz. **The captured particles of an LHC bunch are contained within an RF bucket 1–1.5 ns long (4 sigma length).** Ideally, all particles should be contained within the nominally filled RF bins. Experience has shown that this is typically **correct to an accuracy of about 1–2%** for LHC p beams and about 5% for LHC Pb beams (except when problems with, for example, the RF cavities occur). To obtain a precision better than this on the bunch populations of the nominally filled RF bins, it is necessary to consider the full longitudinal distribution of the two rings. Figure 1 shows a typical distribution for a Pb beam. One observes that particles are captured in every RF bin. Conventionally, the small bunches in those RF bins which are within the 12.5 ns range around the center of a nominally filled RF bin are called **satellite bunches**, while those which are outside this range are lumped altogether in the so-called **ghost charge**.

Some details on the bunch structure...2

The total beam population of beam $j = 1$ or 2 (measured with the DCCTs [3]) is assumed to be the sum of the following components

$$N_{tot, j} = N_{main, j} + N_{ghost, j} + N_{pilots, j} . \quad (1)$$

where $N_{main, j}$ is the charge of all slots nominally filled with a high intensity bunch (a ‘main’ bunch), $N_{ghost, j}$ is the ghost charge and $N_{pilots, j}$ the charge of all slots containing a ‘pilot’ bunch (not used in all fills, see below). In our definition, **the term $N_{main, j}$ is what is needed to determine the scale of the cross section, after correcting for the effects of satellite bunches.**

Bunch current measurements

- Currents are crucial input to VdM scan analysis
 - DC Beam Current Transformer (DCCT)
 - **total** circulating charges
 - Fast Beam Current Transformer (FBCT)
 - **fraction** of charge in each bunch
 - In 2010 uncertainty on bunch current product (10%) dominated luminosity uncertainty, due to major effort this uncertainty is well below **0.5% today [13]**
- Corrections for ghost and satellite bunches
 - Fill dependent, but typically < 1%
 - Measured with various methods
 - Synchrotron radiation by LDM (for satellite bunches) [6]
 - BGI in LHCb VELO with SMOG (for ghost charge) [7]

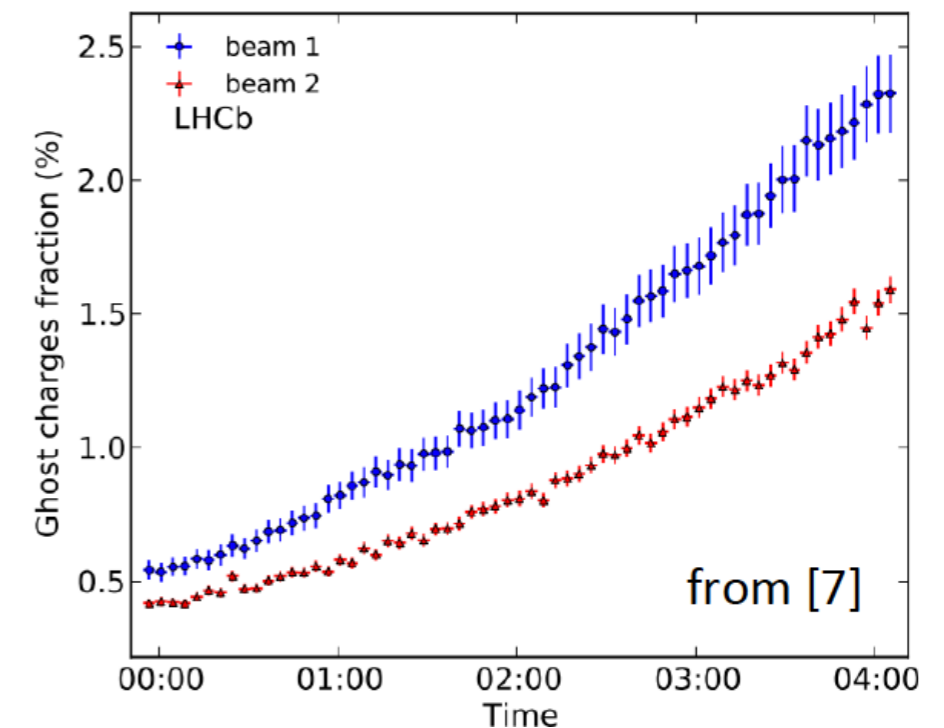
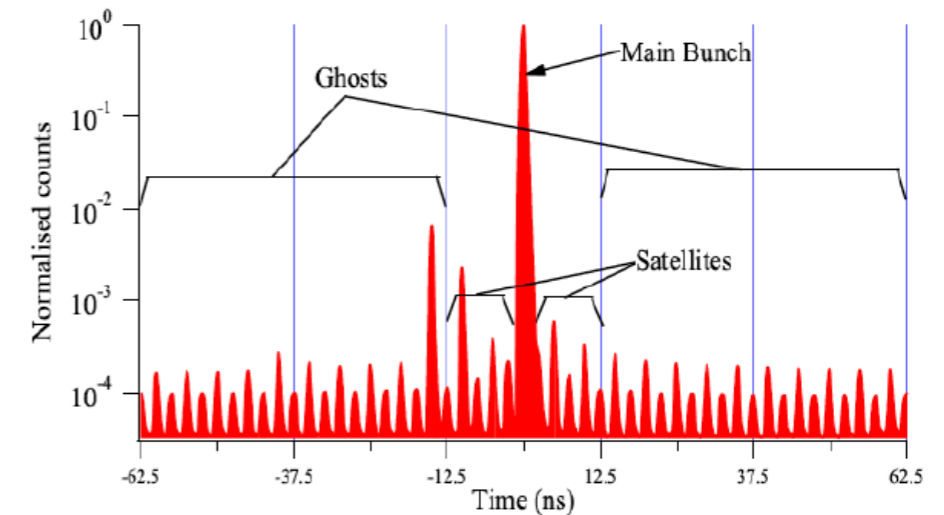

VdM scans in ATLAS

Table 2 Summary of the main characteristics of the 2010 and 2011 *vdM* scans performed at the ATLAS interaction point. Scan directions are indicated by “H” for horizontal and “V” for vertical. The values of luminosity/bunch and μ are given for zero beam separation.

Scan Number	I	II–III	IV–V	VII–IX
LHC Fill Number	1059	1089	1386	1783
Date	26 Apr., 2010	9 May, 2010	1 Oct., 2010	15 May, 2011
Scan Directions	1 H scan followed by 1 V scan	2 H scans followed by 2 V scans	2 sets of H plus V scans	3 sets of H plus V scans (scan IX offset)
Total Scan Steps per Plane	27 ($\pm 6\sigma_b$)	27 ($\pm 6\sigma_b$)	25 ($\pm 6\sigma_b$)	25 ($\pm 6\sigma_b$)
Scan Duration per Step	30 s	30 s	20 s	20 s
Bunches colliding in ATLAS & CMS	1	1	6	14
Total number of bunches per beam	2	2	19	38
Typical number of protons per bunch ($\times 10^{11}$)	0.1	0.2	0.9	0.8
Nominal β -function at IP [β^*] (m)	2	2	3.5	1.5
Approx. transverse single beam size σ_b (μm)	45	45	57	40
Nominal half crossing angle (μrad)	0	0	+100	+120
Typical luminosity/bunch ($\mu\text{b}^{-1}/\text{s}$)	$4.5 \cdot 10^{-3}$	$1.8 \cdot 10^{-2}$	0.22	0.38
μ (interactions/crossing)	0.03	0.11	1.3	2.3

Low luminosity runs, clean measurement

ATLAS Beam Profiles

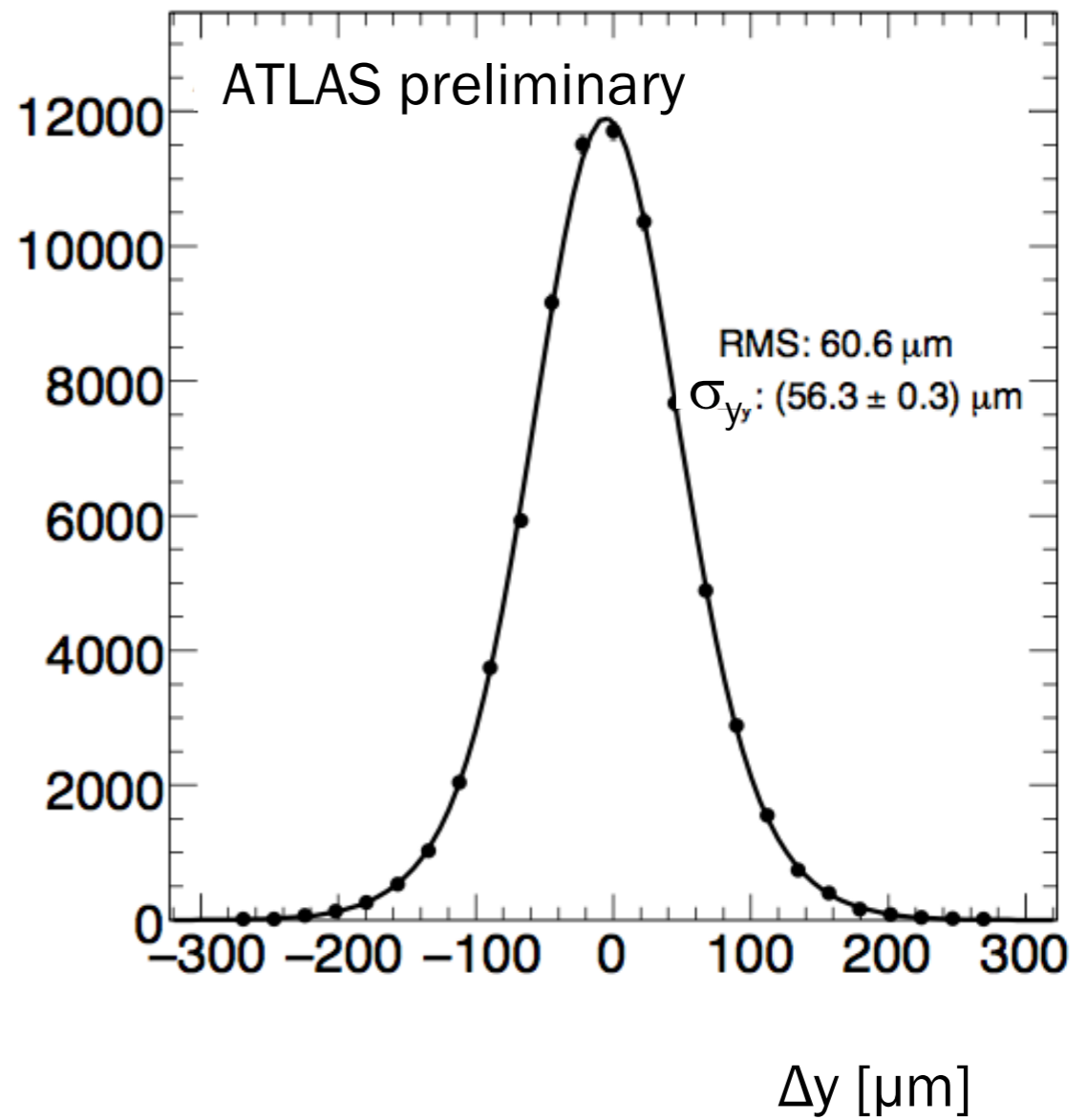
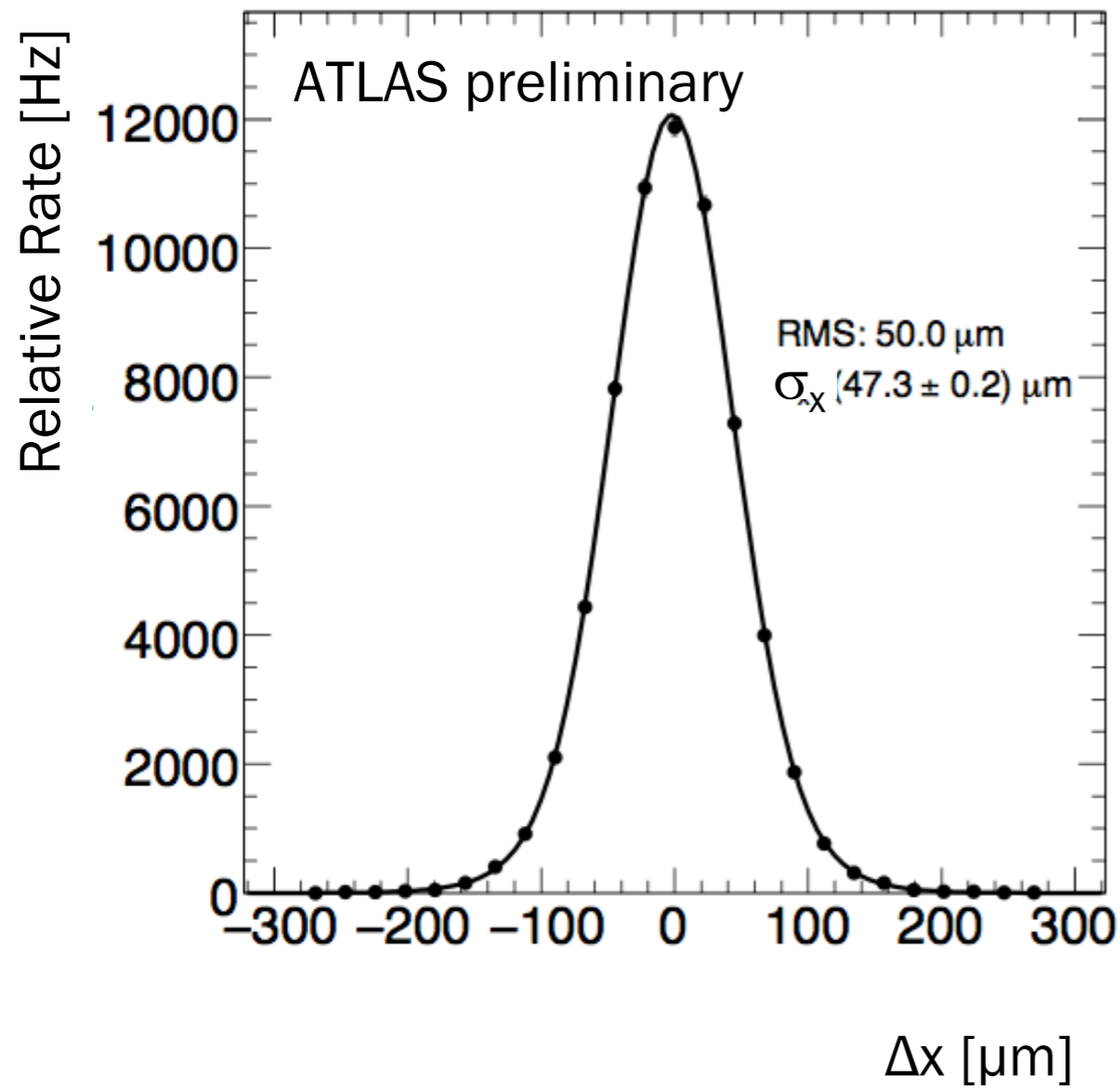

Profile of VdM scan

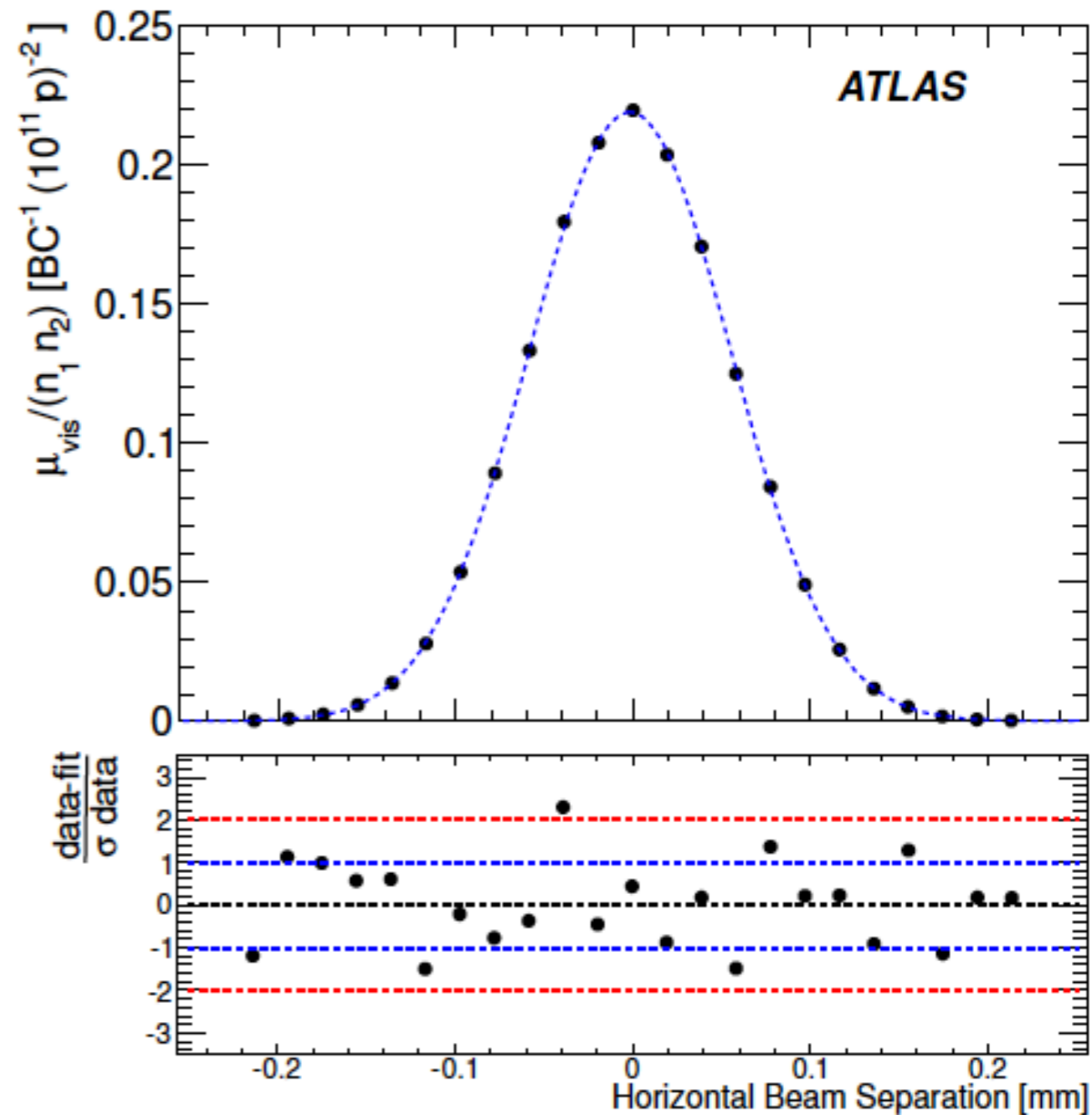
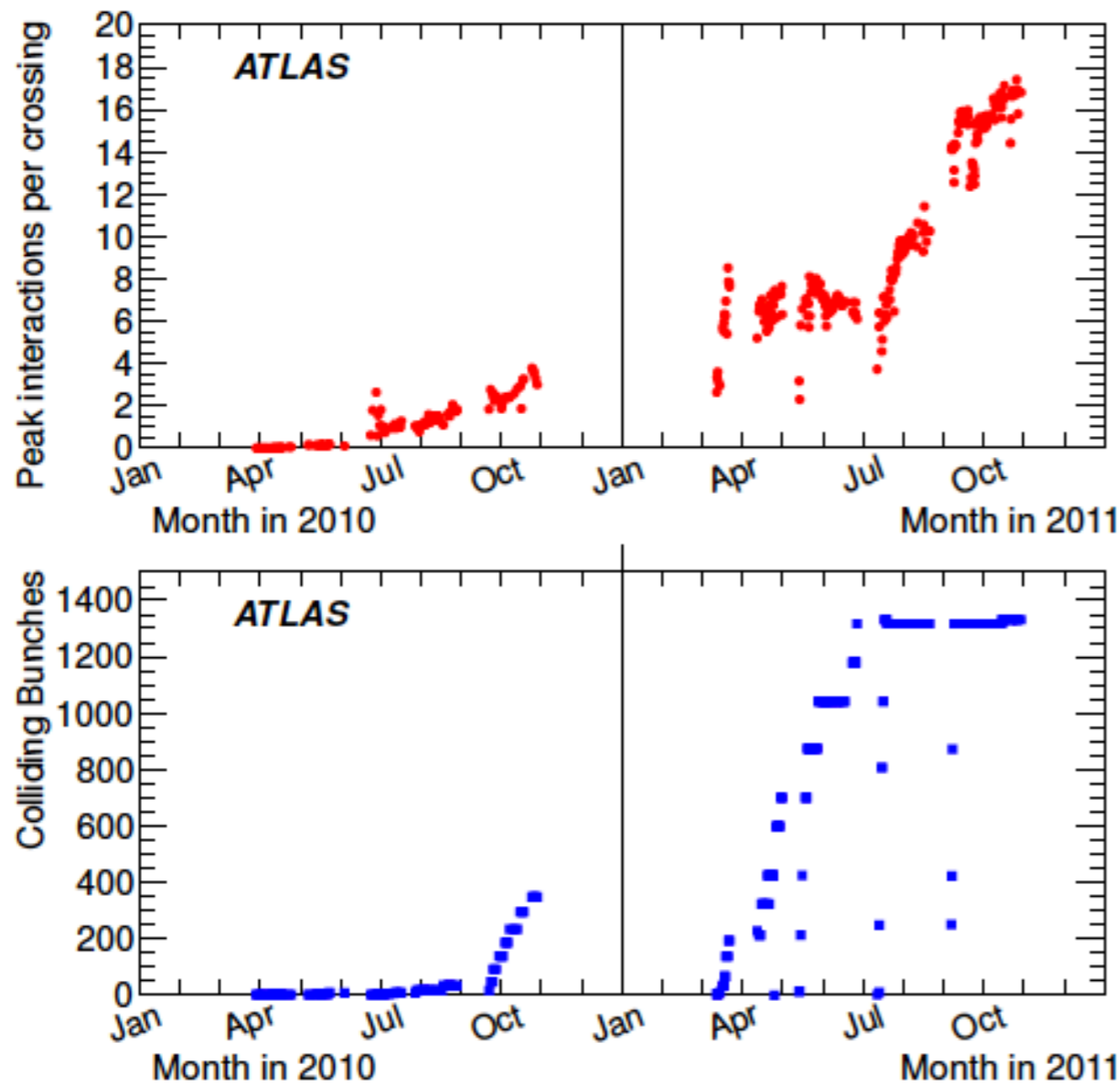

Fig. 1 Average number of inelastic pp interactions per bunch crossing at the start of each LHC fill (above) and number of colliding bunches per LHC fill (below) are shown as a function of time in 2010 and 2011. The product of these two quantities is proportional to the peak luminosity at the start of each fill.

Syst. errors in luminosity measurement

Table 6 Relative systematic uncertainties on the determination of the visible cross-section σ_{vis} from vdM scans in 2010. The assumed correlations of these parameters between scans is also indicated.

Scan Number	I	II–III	IV–V	
Fill Number	1059	1089	1386	
Beam centring	2%	2%	0.04%	Uncorrelated
Beam-position jitter	–	–	0.3%	Uncorrelated
Emittance growth and other non-reproducibility	3%	3%	0.5%	Uncorrelated
Fit model	1%	1%	0.2%	Partially Correlated
Length scale calibration	2%	2%	0.3%	Partially Correlated
Absolute length scale	0.3%	0.3%	0.3%	Correlated
Beam–beam effects	–	–	0.7%	Uncorrelated
Transverse correlations	3%	2%	0.9%	Partially Correlated
μ dependence	2%	2%	0.5%	Correlated
Scan subtotal	5.6%	5.1%	1.5%	
Bunch population product	5.6%	4.4%	3.1%	Partially Correlated
Total	7.8%	6.8%	3.4%	

An alternative approach: BGI

- **Beam-Gas imaging** (pioneered by LHCb) [1]
 - Reconstruct interaction vertices of protons with residual gas
 - Infer beam shape near interaction point (IP) and extrapolate to IP
- **Combination** of Beam-Gas and Beam-Beam vertices
 - **Simultaneous fit** to individual beam and luminous region shapes **yields beam overlap integral and then luminosity**
 - Beams do **not need to be moved** (hence no beam-beam corrections, etc.)
 - Overall calibration uncertainty dominated by vertex resolution
 - Several important systematic uncertainties are **independent** from VdM scan analysis

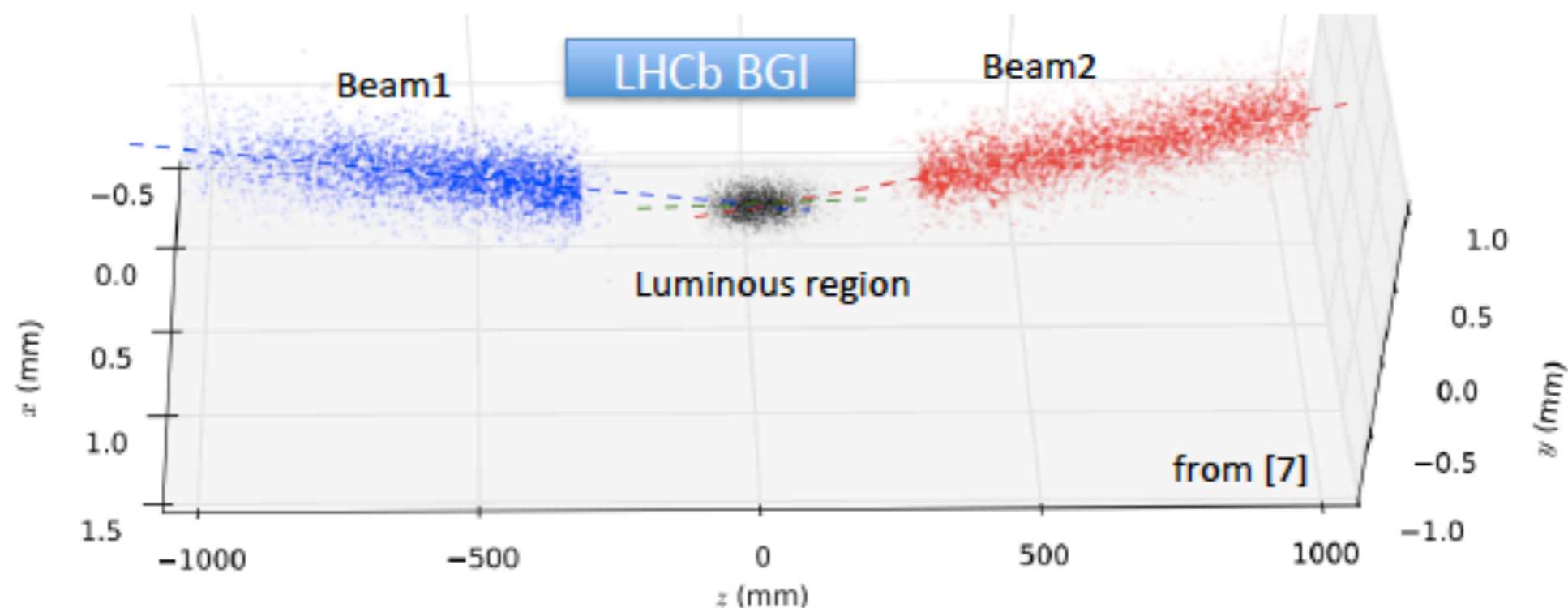

08/11/14

7

Uncertainties - 1

- Only a selection of the most important systematic uncertainties is listed in the following

Calibration uncertainties	VdM scan	BGI
	Scan curve model	Bunch shape model (accounts for factorizability)
	Factorizability	
	Beam-Beam effects	Vertexing resolution
	Orbit drifts	Detector alignment & crossing angle
	Reproducibility	
Calibration transfer uncertainties from low \mathcal{L} calibration to high \mathcal{L} physics	μ -dependence	
	Radiation effects	
Monitoring uncertainty	Long-term stability	

Uncertainties - 2

Choice of scan curve model

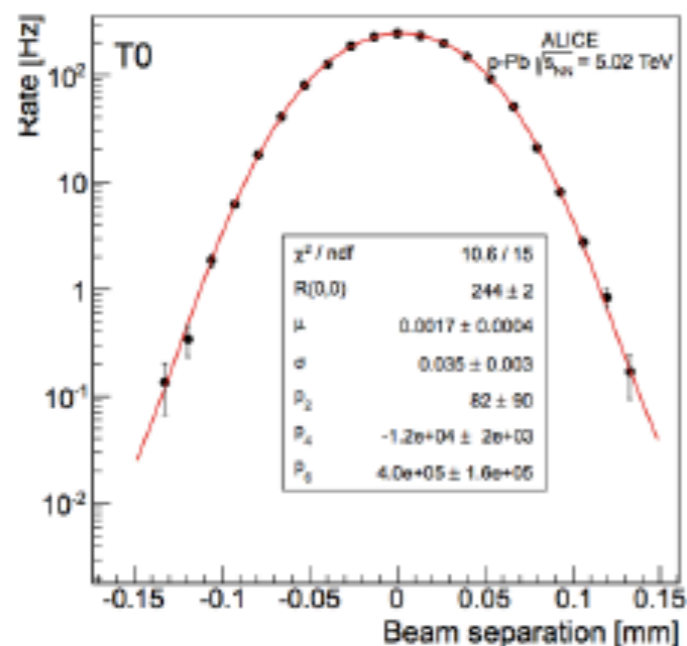

Orbit drifts

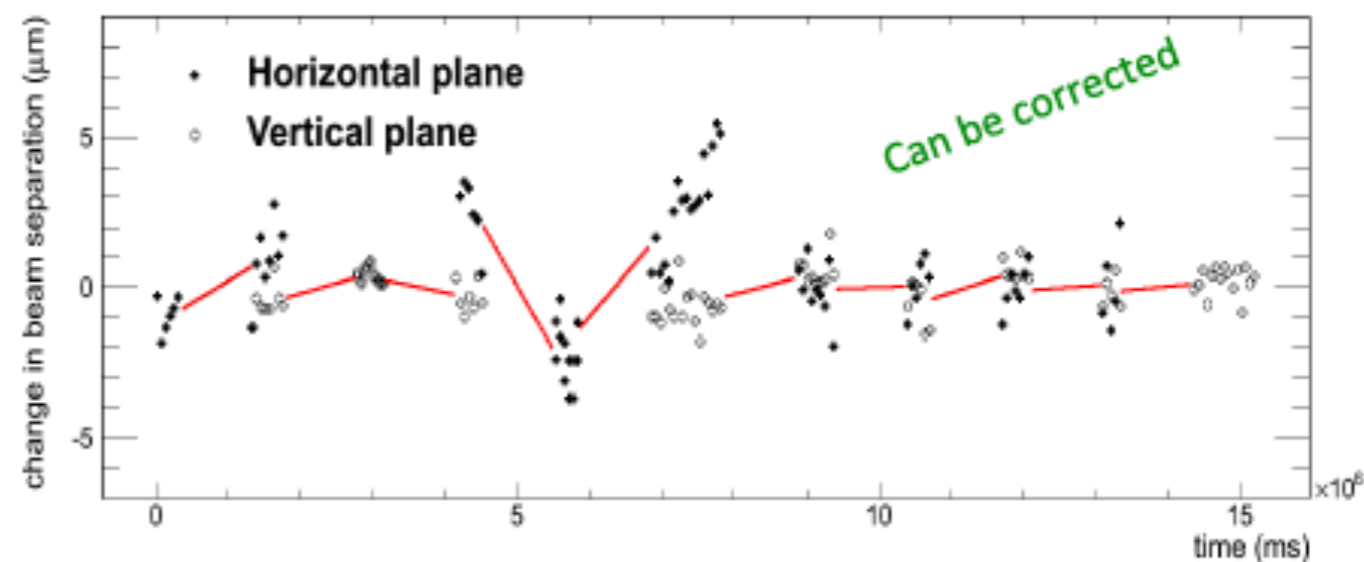

Beam-beam effects

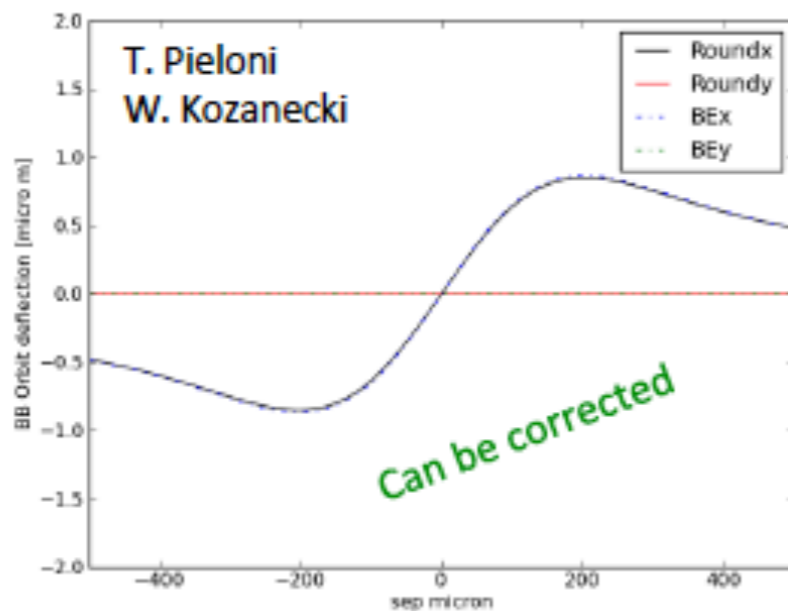

Beam-beam deflection

- Orbit shift dependent on beam separation

Dynamic β

- Beam sizes vary during VdM scan since beams exert focussing/defocussing force on each other

Uncertainties - 3

- Non-factorizability of beam densities could be tracked down as the **source for significant inconsistencies** in some VdM scans
 - Its effect on VdM scans is new territory and was first studied at LHC
- Two approaches to deal with the factorizability problem
 - Accelerator experts **prepare good beams** which have approx. factorizable densities
 - Experiments measure the non-factorizability and develop **new methods to correct** for it (based on BGI, luminous-region evolution during scan)

Difference between factorizable and non-factorizable model

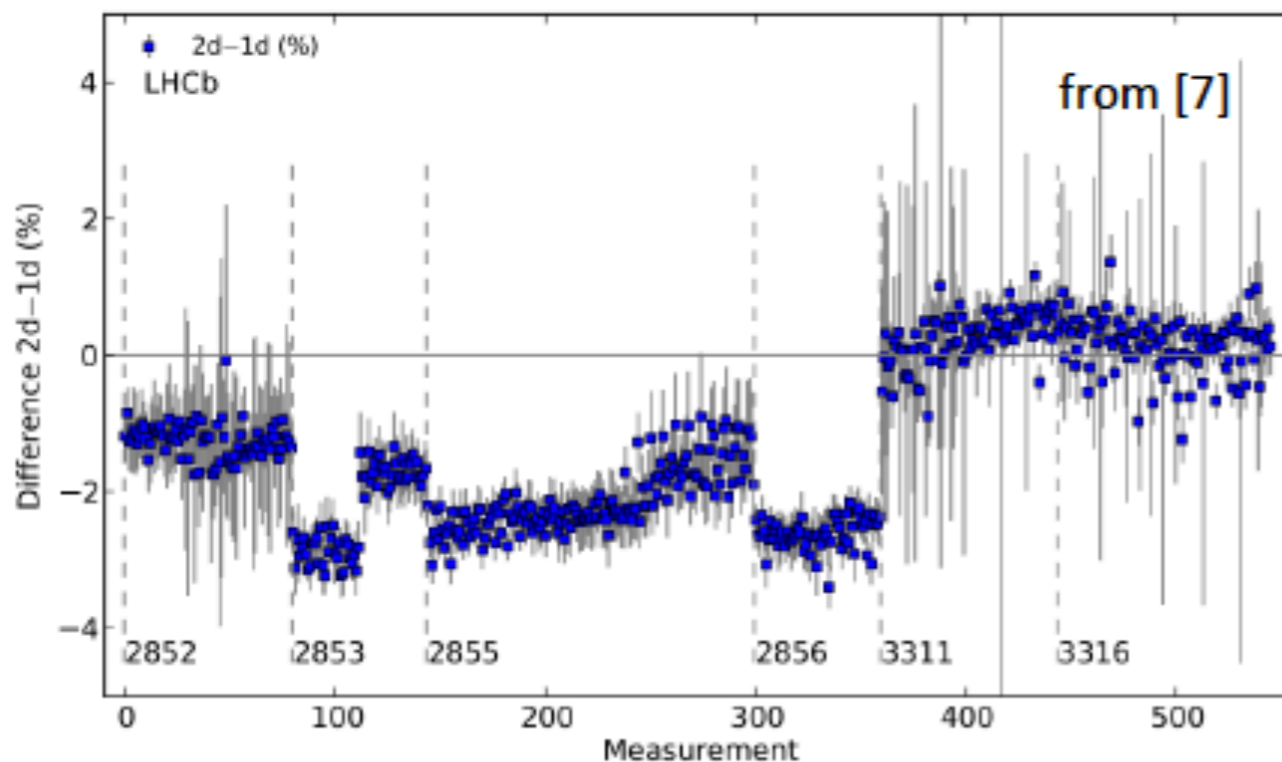

Monitoring the luminous region during VdM scans

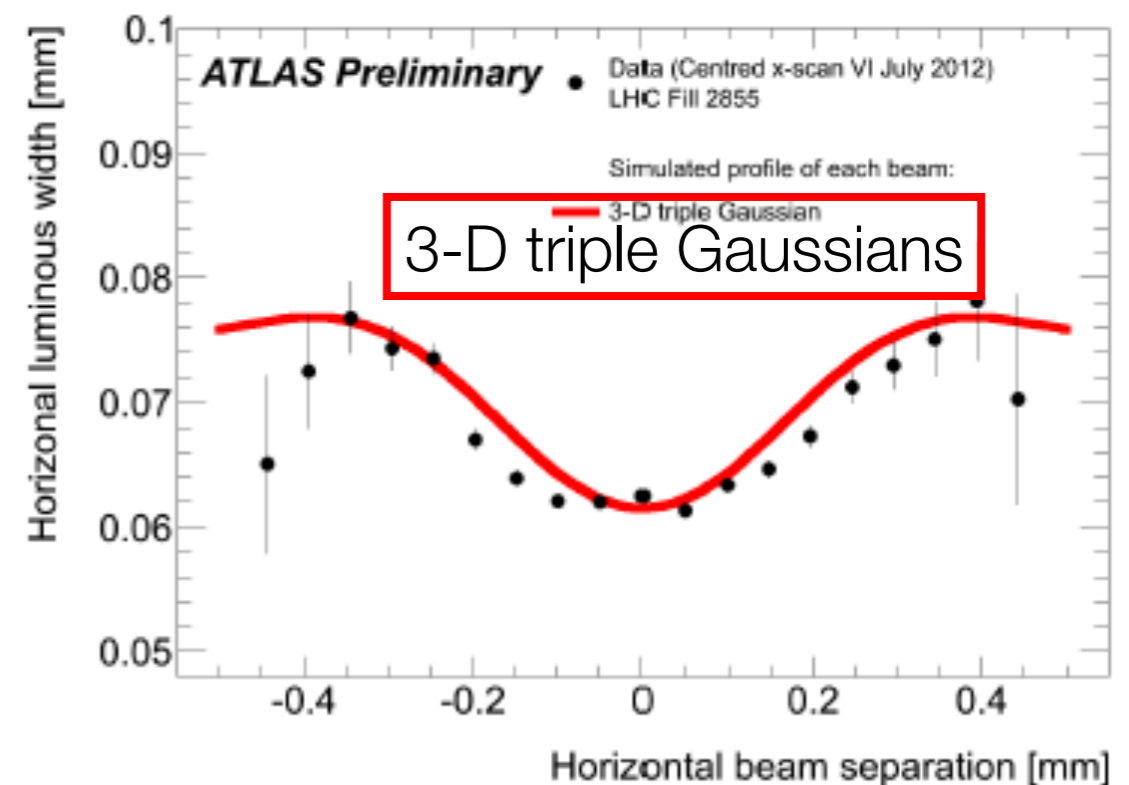

Snapshot of Luminosities uncertainties

Parts of table reproduced from [11]

	ALICE	ATLAS	CMS	LHCb
Running period	2013	2011	2012	2012
Sqrt(s) [TeV]	5.02	7	8	8
Running mode	Pb-p	p-p	p-p	p-p
Reference	[8]	[9]	[10]	In the process of being made publicly available
Absolute calibration method	VdM	VdM	VdM	VdM + BGI *
$\Delta\sigma_{vis}/\sigma_{vis}$ [%]	2.8	1.53	2.3	1.12
μ-dependence [%]	1.0	0.50	<0.1	0.17
Long-term stability [%]		0.70	1.0	0.22
Subtraction of luminosity backgrounds [%]		0.20	0.5	0.13
Other luminosity-dependent effects [%]		0.25	0.5	-
Total luminosity uncertainty [%]	3.0	1.8	2.6	1.2

*uncertainties of both methods almost equal in size

This snapshot represents a selection of the latest luminosity calibration results publicly available

Luminosity via Forward Scattering

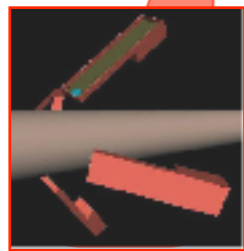
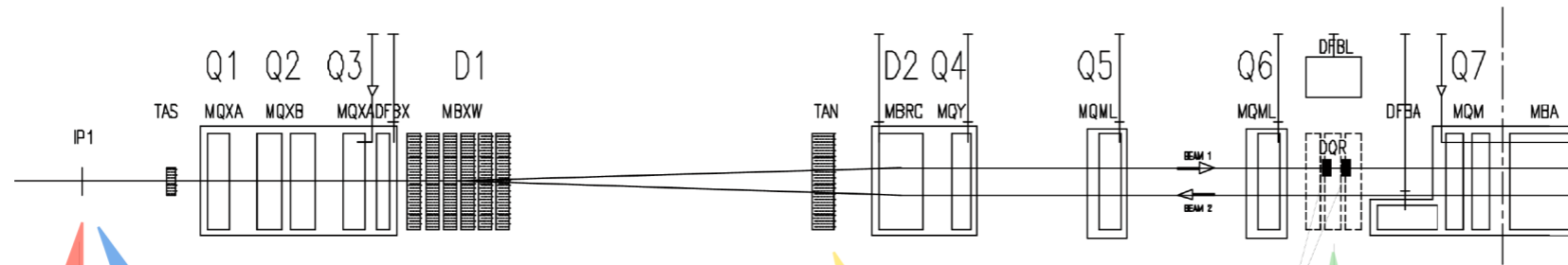

BCM
[Beam Condition Monitor]
Diamond sensors
at $z = \pm 184$ cm
4 modules per side



LUCID
[Luminosity Monitor]
Cherenkov gas tubes,
at ~ 17 m from IP.



ZDC
[Forward Neutrals]
 W^{74} / Quartz calo
at 140 m and at 0° to IP.

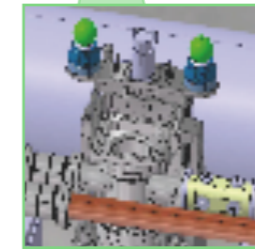

ALFA
[Absolute Lumi ...]
Fiber trackers
in "Roman Pots" ...
at 240 m ...

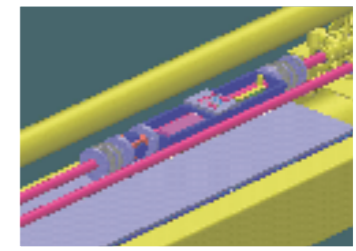

AFP
[Track & ToF System]
LHC Upgrade ...
at 220 and 420 m ...

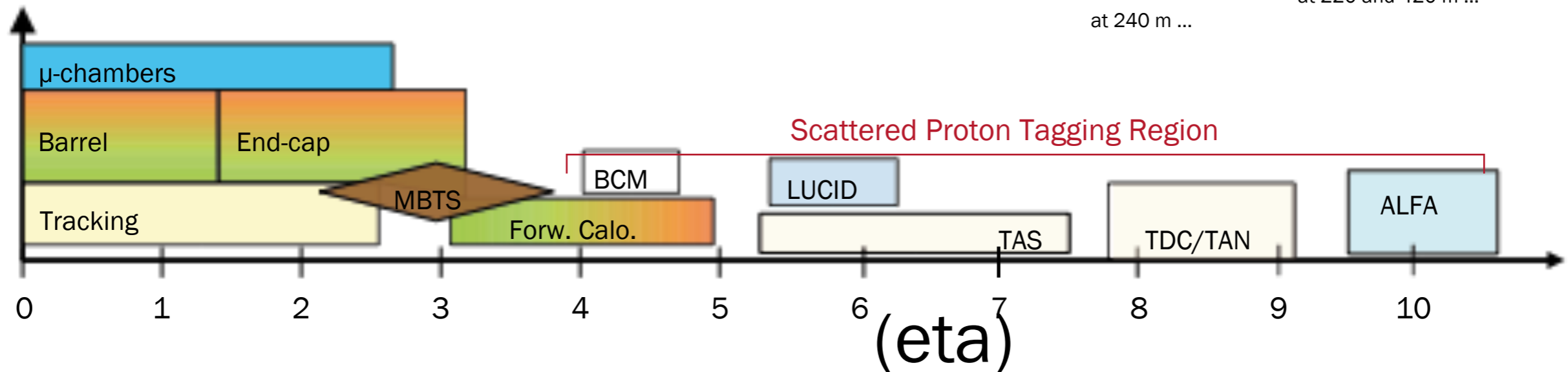

Optical theorem basics

- TOTEM for CMS and ALFA for ATLAS are able to perform absolute luminosity measurements
- **Based on Optical theorem**
 - Measurements of the total rate in combination with the t -dependence of the elastic cross section (TOTEM)
 - Measurements of elastic scattering rates in the Coulomb interference region (ALFA)

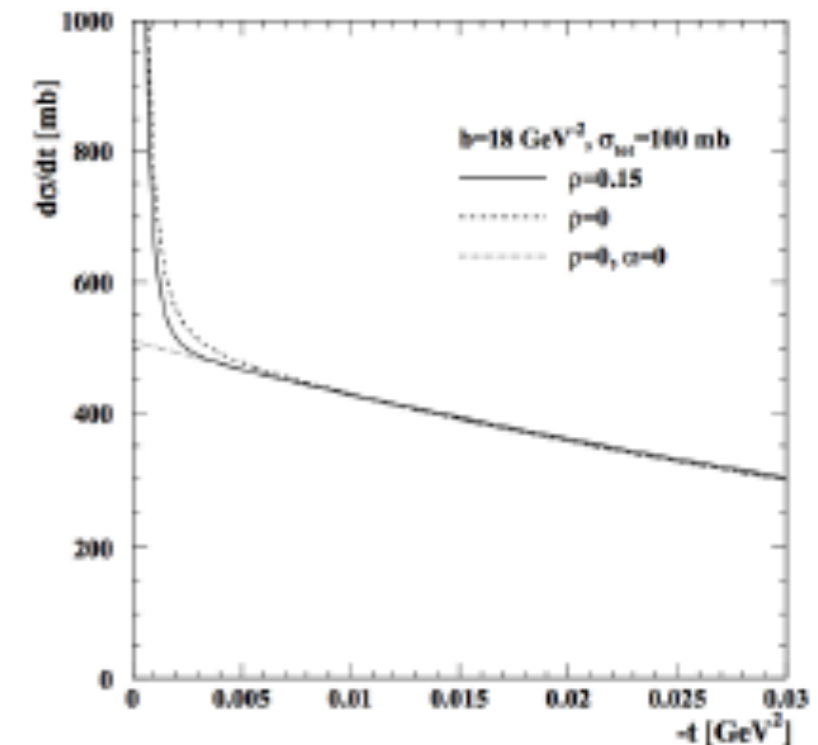

- Requires dedicated LHC fills with special magnet settings
- Roman pots far from the interaction points (about 200 m)
- Measurements at very low interaction rates
 - Cross-calibration of dedicated luminosity detectors
 - Extrapolation of calibration to typical physics conditions introduces big uncertainties
- **Valuable cross check but at LHC not competitive to VdM scans for integrated luminosity measurements**

ALFA – Absolute Luminosity for ATLAS

Elastic Scattering:

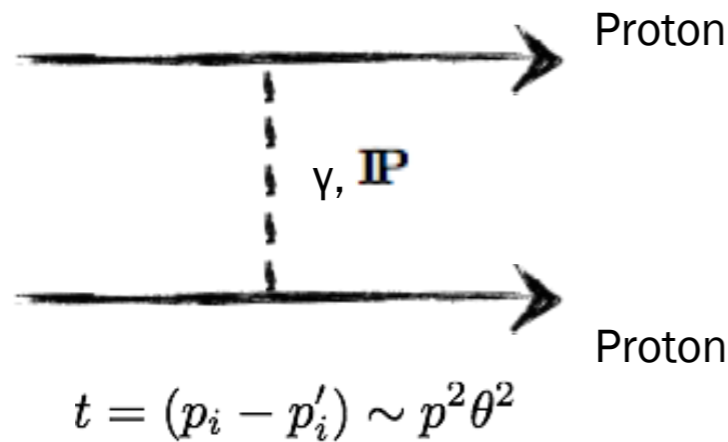

Elastic Scattering at low t is sensitive to exactly known Coulomb amplitude ...

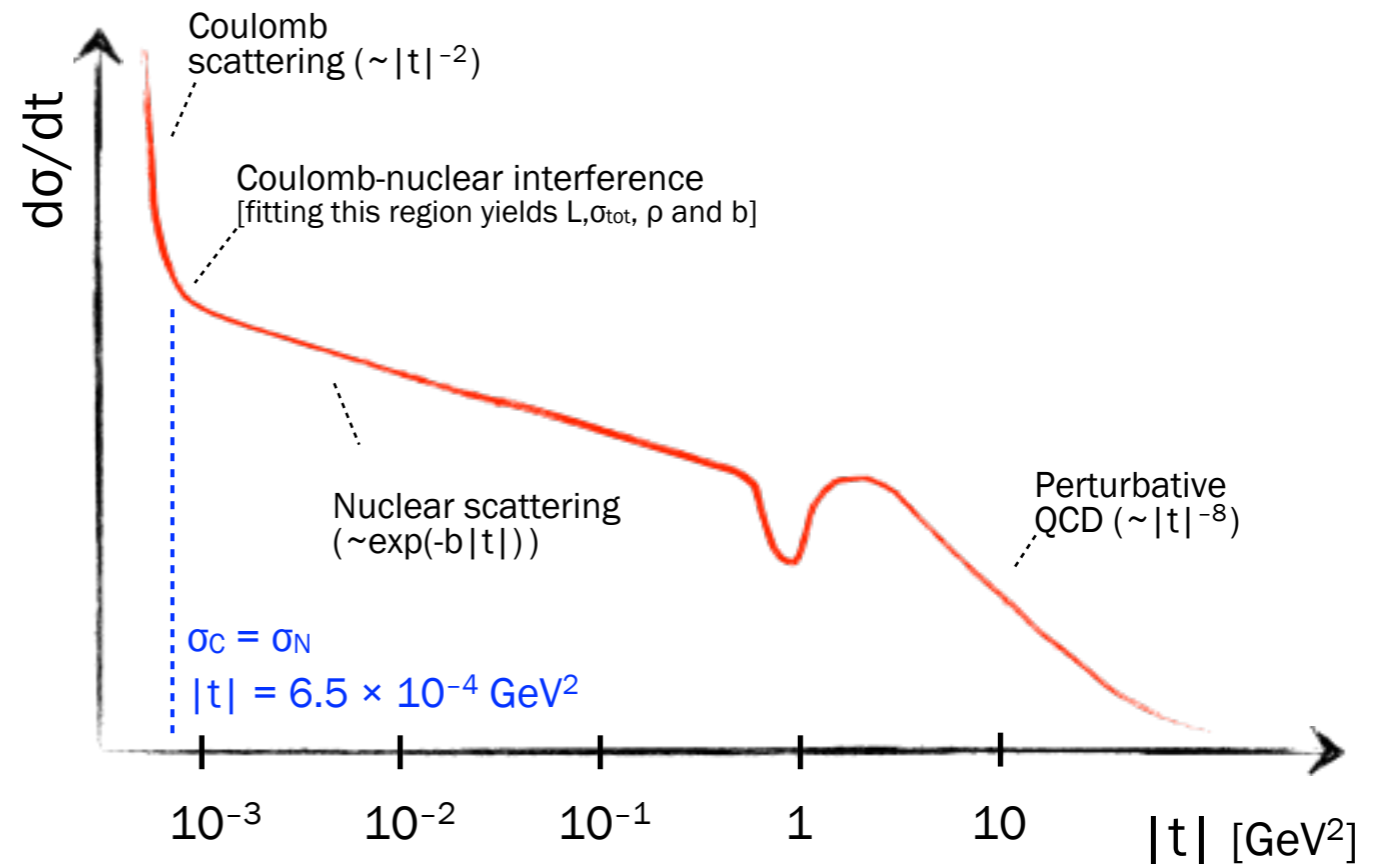

Shape of elastic scattering distribution can also be used to determine total cross section, σ_{tot} , and the parameters ρ and b ...

Perform fit to:

$$\frac{dN}{dt} = L \left(\underbrace{\frac{4\pi\alpha^2}{|t|^2}}_{\text{Coulomb Scattering}} - \underbrace{\frac{\alpha\rho\sigma_{\text{tot}}e^{-\frac{b|t|}{2}}}{|t|}}_{\text{Coulomb/nuclear Interference}} + \underbrace{\frac{\sigma_{\text{tot}}^2(1+\rho^2)e^{-b|t|}}{16\pi}}_{\text{Nuclear Scattering}} \right)$$

with:

- ρ : ratio of the real to imaginary part of the elastic forward amplitude
- b : nuclear slope
- σ_{tot} : total $pp \rightarrow X$ cross section

ALFA – Absolute Luminosity for ATLAS

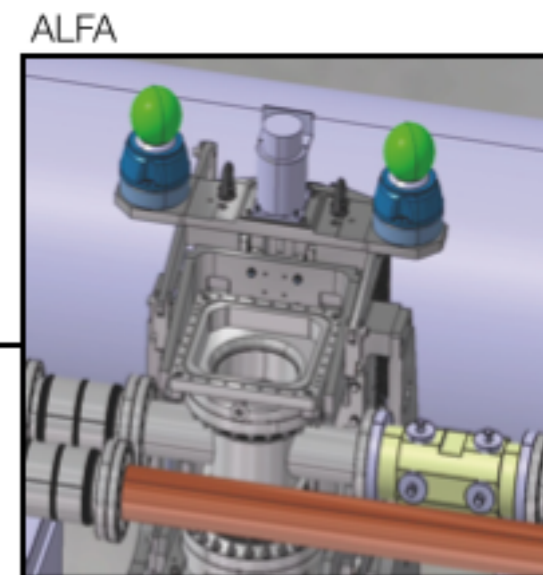

Elastic Scattering:

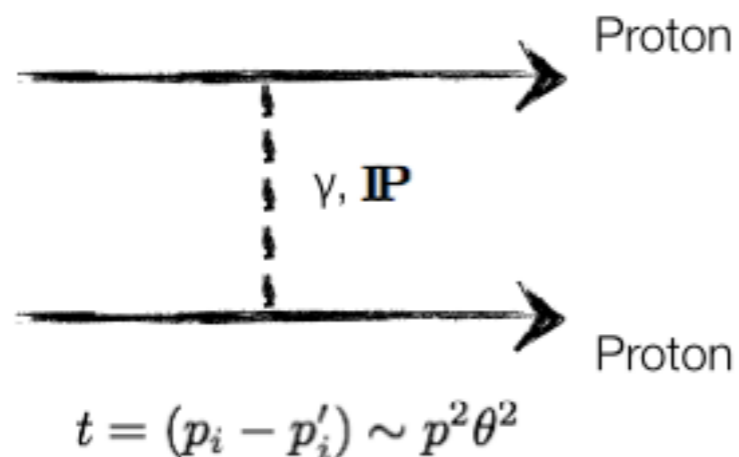

$$t \approx 10^{-3} \text{ GeV}^2$$

$$\theta \approx 5 \cdot 10^{-6} = 5 \mu\text{rad}$$

$$L_{\text{eff}} \approx 240 \text{ m}$$

[Depends on beam optics]

$$y_{\text{det}} \approx 1.5 \text{ mm}$$

→ Need proton detection
1.5 mm from beam ...

Use of Roman Pot detectors ..

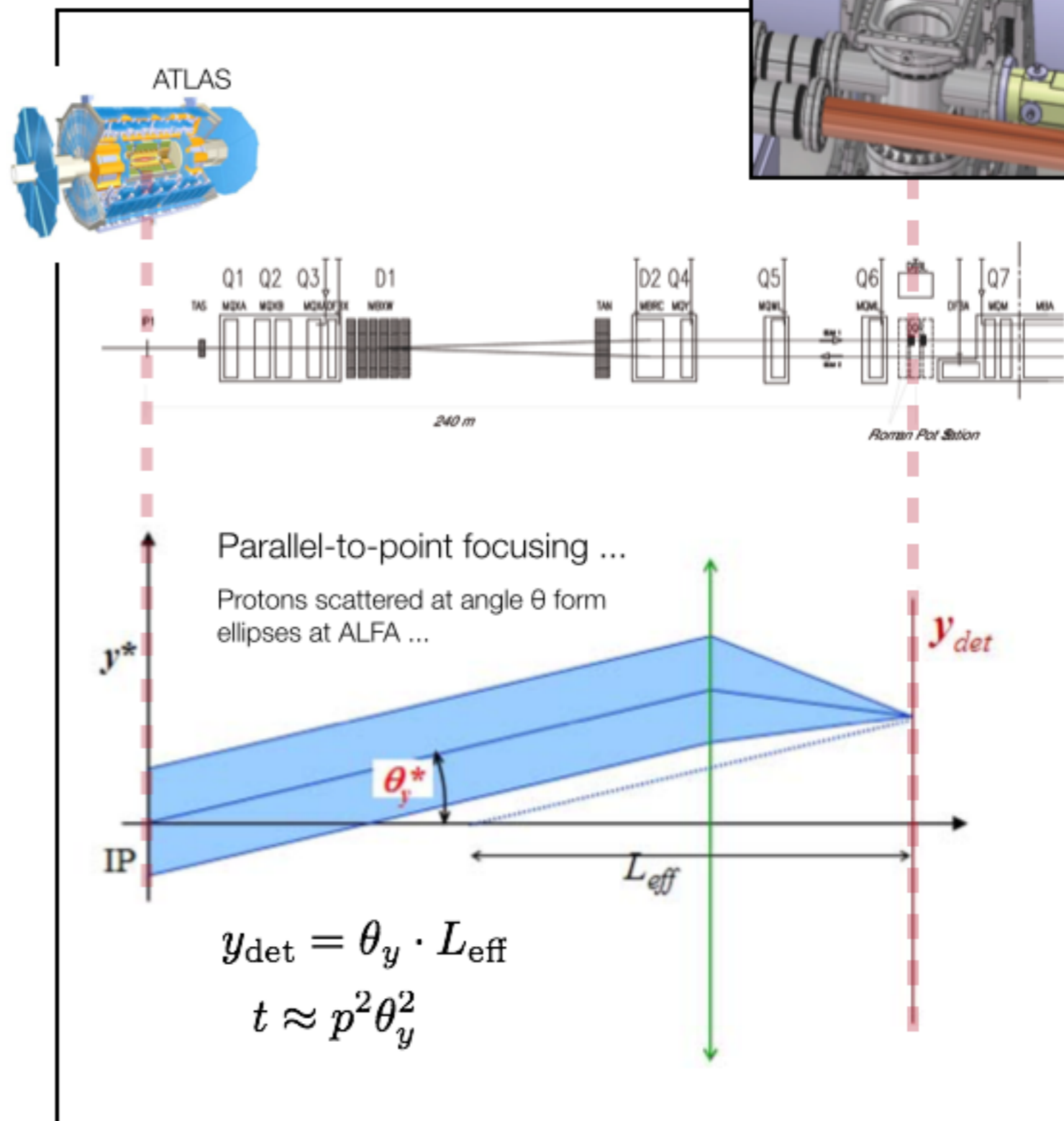

AFP & ALFA : geometry

Forward Detectors @ IP1

Intact protons → natural diffractive signature → usually scattered at very small angles (μrad) → detectors must be located far from the Interaction Point.

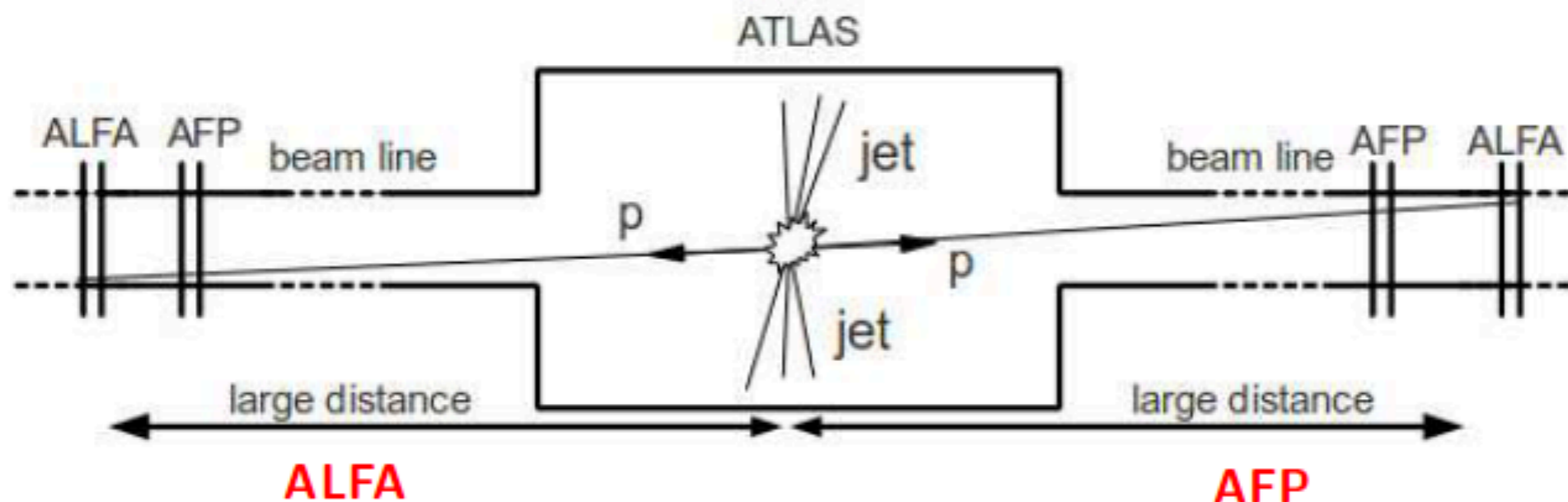

- Absolute Luminosity For ATLAS

- exist, 240 m from ATLAS IP

- soft diffraction (elastic scattering)

- special runs (high β^* optics)

- vertically inserted Roman Pots

- tracking detectors, resolution:

$$\sigma_x = \sigma_y = 30 \mu\text{m}$$

- ATLAS Forward Proton

- planned, 210 m from ATLAS IP

- hard diffraction

- nominal runs (collision optics)

- horizontally inserted Roman Pots

- tracking detectors, resolution:

$$\sigma_x = 10 \mu\text{m}, \sigma_y = 30 \mu\text{m}$$

- timing detectors, resolution:

$$\sigma_t \sim 20 \text{ ps}$$

Similar Devices @ IP5: CMS-TOTEM.

ALFA – Absolute Luminosity for ATLAS

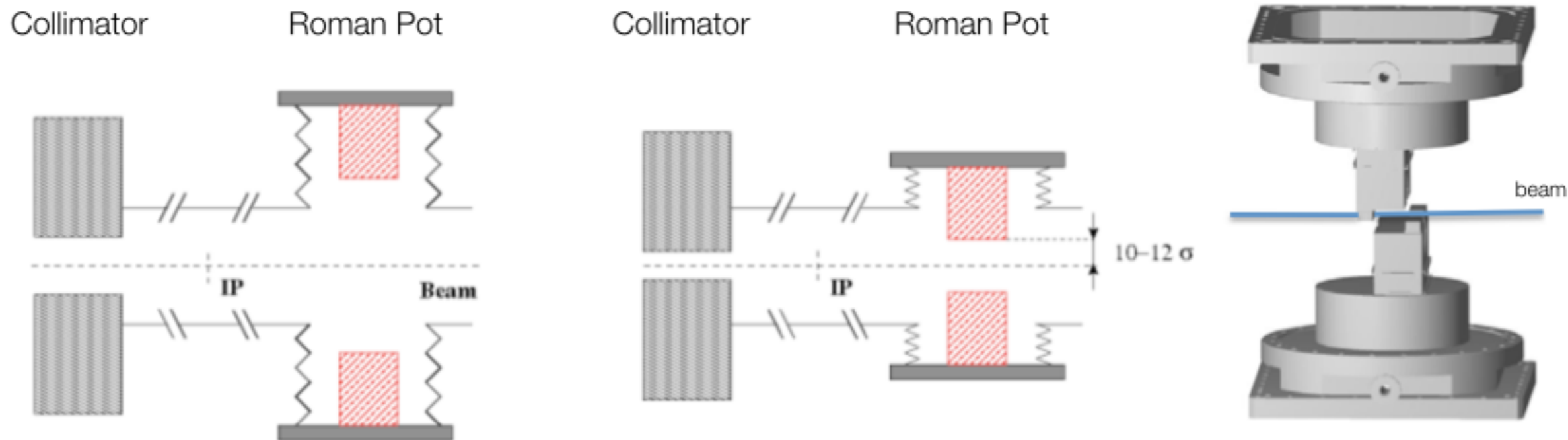

Roman Pots, based on modified Totem design, used to move detectors near to stable beam.

Detectors in vertical plane only.

Calibration:

Beam positioning monitors (BPMs) and hit multiplicities used to calibrate detector positions with respect to beam

Overlap extrusions used to calibrate distance between upper and lower detectors

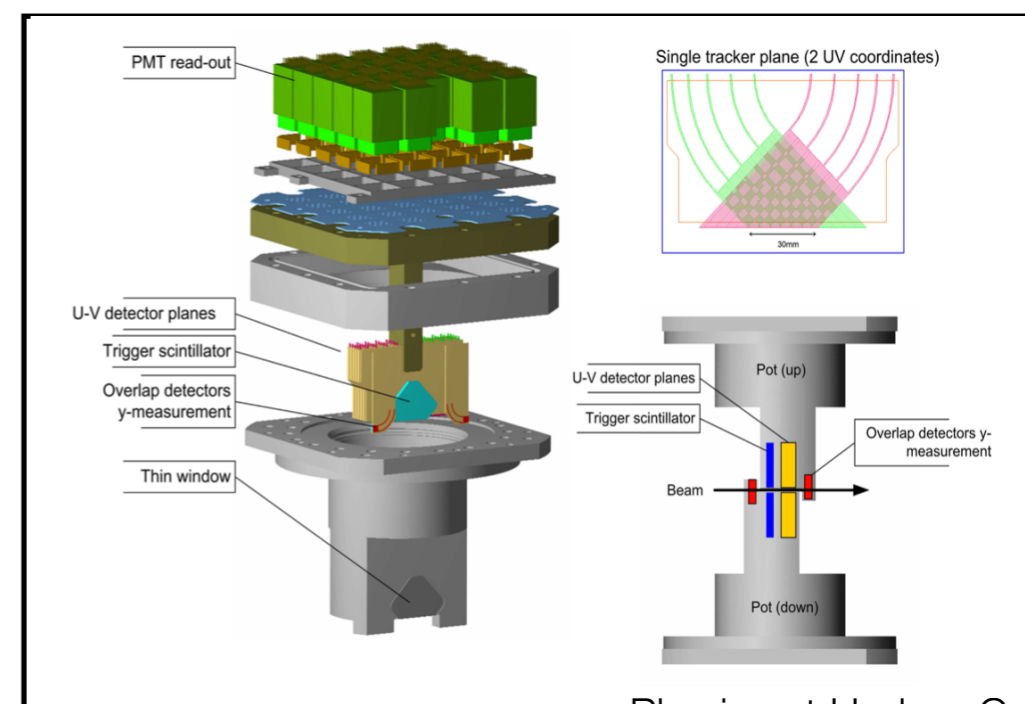

ALFA – Absolute Luminosity for ATLAS

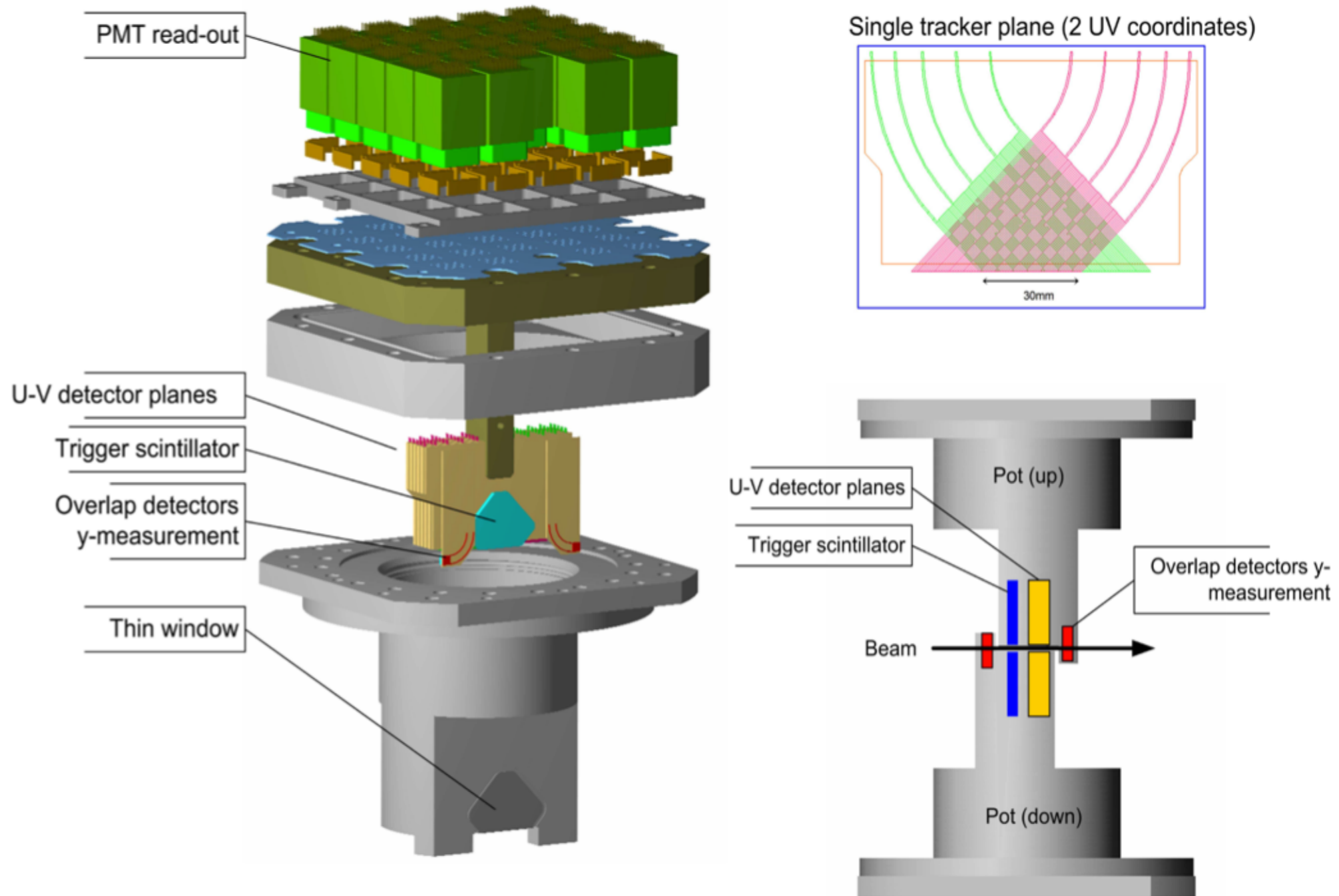

ALFA – Absolute Luminosity for ATLAS

Scintillating fibers
in U-V geometry

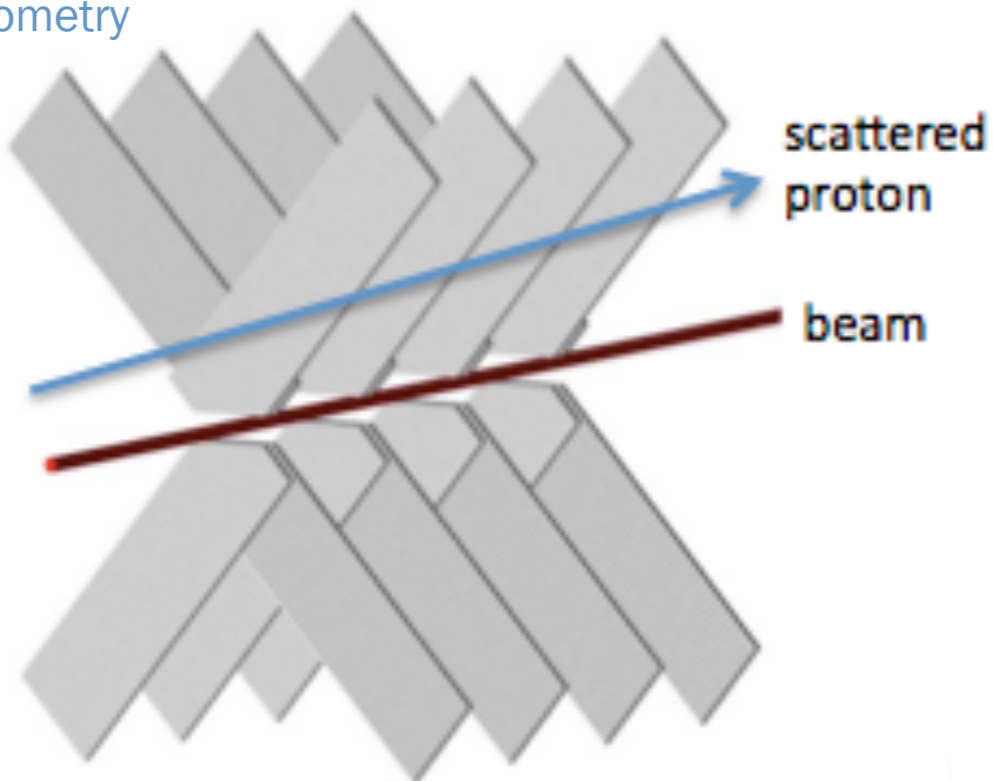

Single-cladded 0.5 mm square fibers
used to track scattered protons ...

20 detector planes with 64 fibers each ...
[expected position resolution: 30 μm]

Dead region less than 100 μm ...

Efficiency > 90% per plane ...

Schematic view of tracker module ...

Sensitive area with U-V geometry (light blue) ...

Overlap detectors and fibers (dark blue) ...

LHC Beam pipe (red) ...

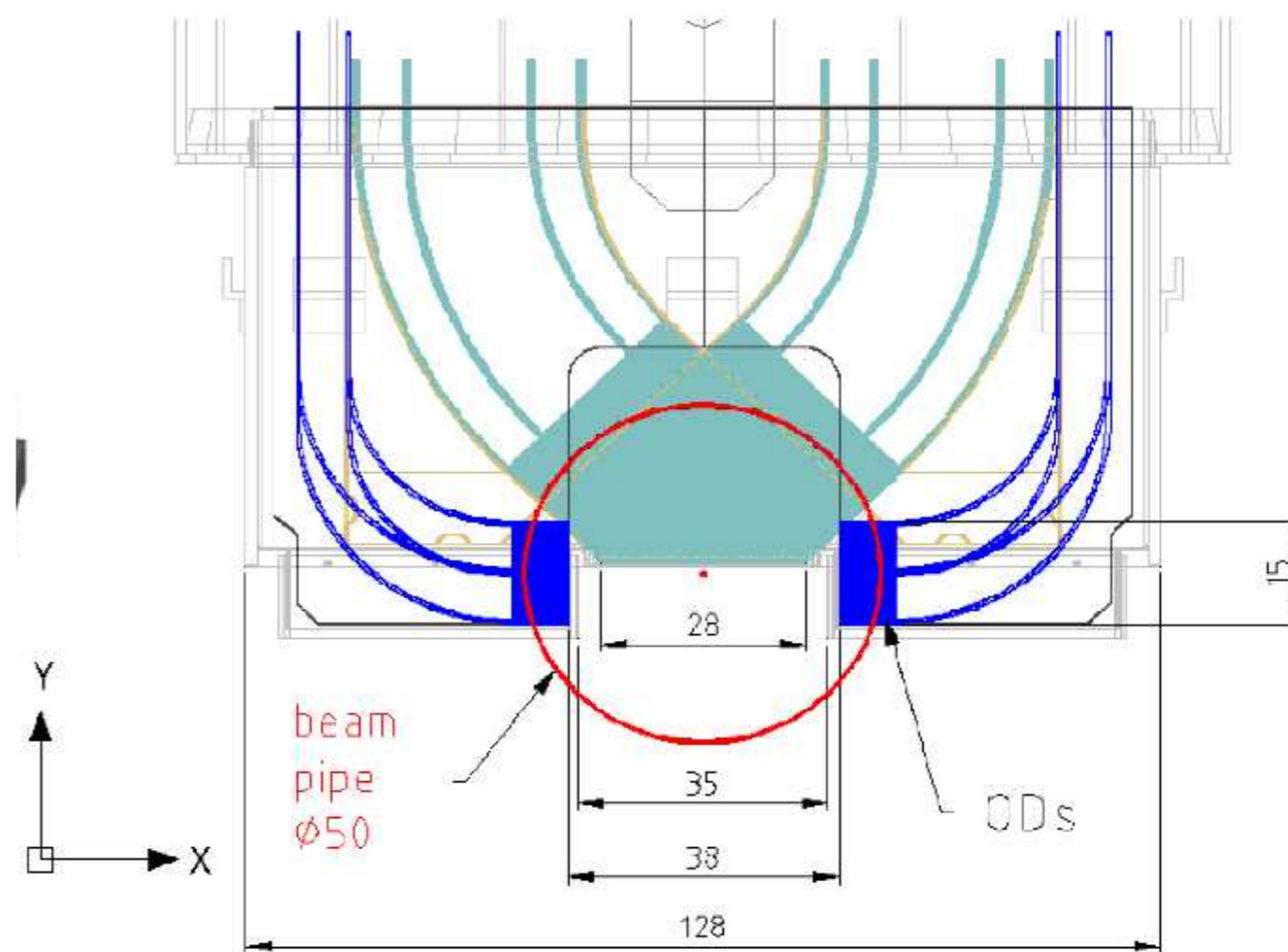

ALFA detector

The Absolute Luminosity For ATLAS (ALFA) detector

- Build to measure elastically scattered protons at μrad angles.
- Located 240 m from the ATLAS interaction point (IP) inside Roman Pots.
- Approaches outgoing beams in vertical direction.
- The main detector (MD) is build of 10×2 orthogonal layers of scintillating fibers.
 - The fiber width of $500 \mu\text{m}$ and layer staggering gives $\approx 30 \mu\text{m}$ tracking resolution.
- The overlap detectors (OD) also use scintillating fibers and are used for detector alignment.
- Trigger tiles of scintillating plastic cover MDs and ODs.

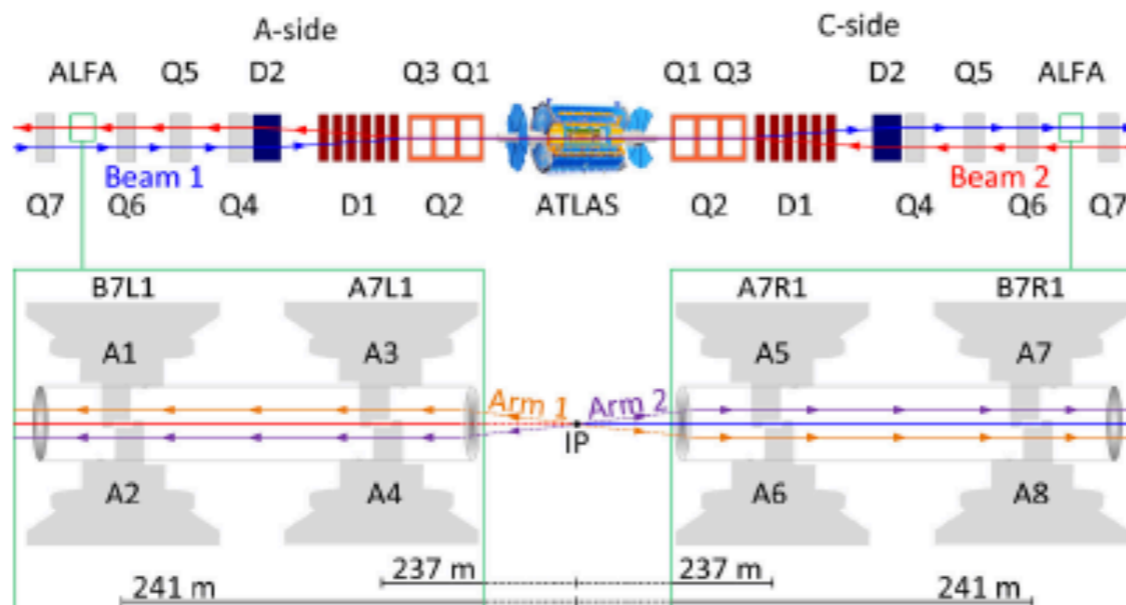
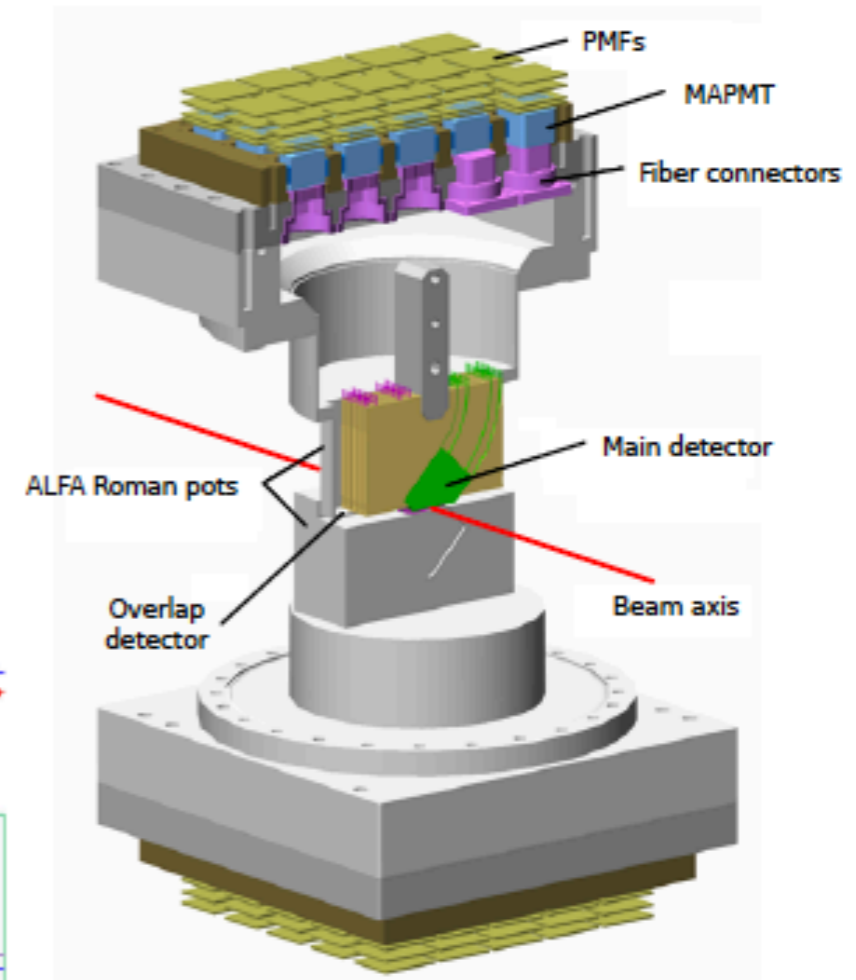

[ATL-LUM-2010-001]

ALFA detector : signal events

Elastic event selection

- Elastic events are selected with tracks in all four stations in an arm.
- The tracks are also required to fulfill certain correlations between inner-outer stations and between A-side and C-side.

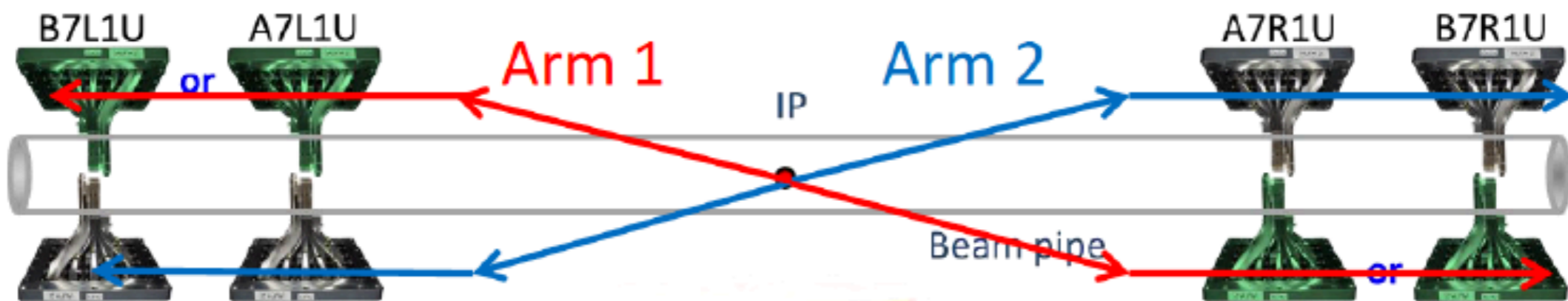
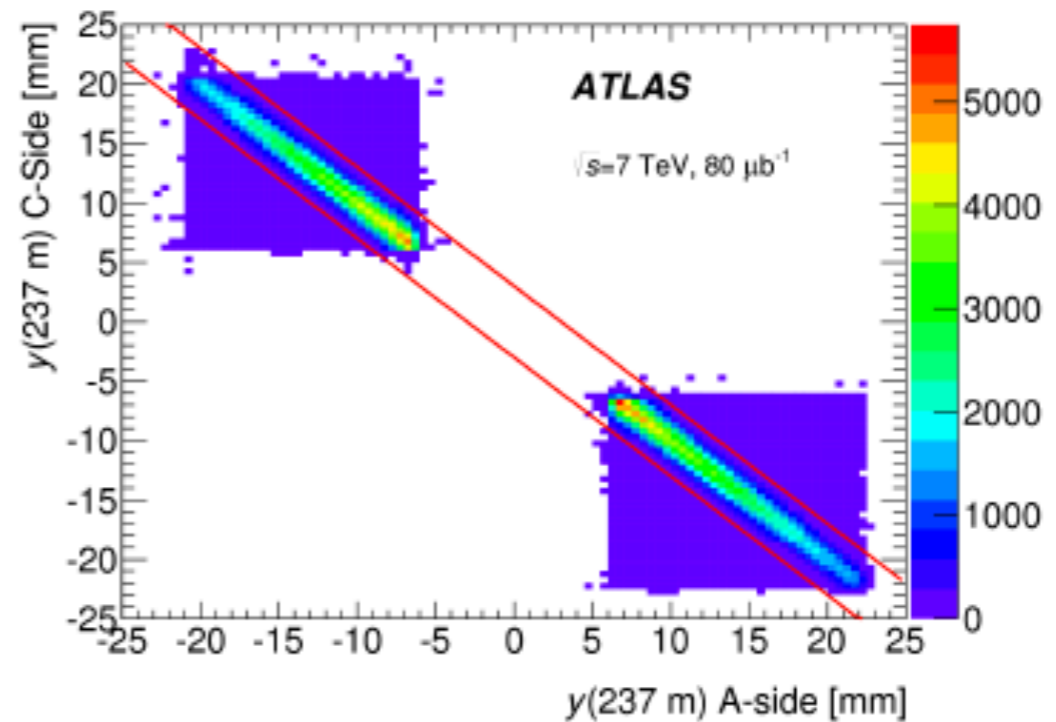

ALFA detector : background events

Background

- Sources of irreducible background is:
 - 1) two incident halo particle,
 - 2) a single diffractive proton and a halo particle,
 - 3) double pomeron exchange with two protons in ALFA.
- A t -spectrum for background is determined from anti-golden events by flipping the coordinates of one of the tracks.
- Background fraction is $\sim 0.5\%$ and halo+halo is the dominant source.

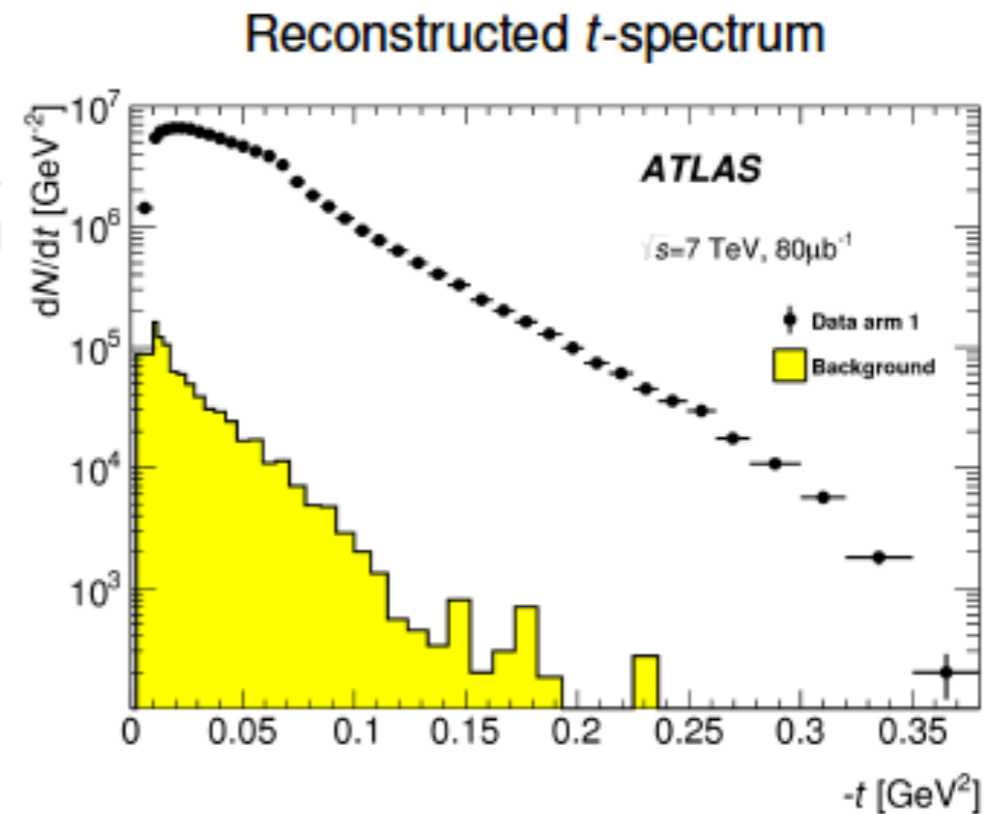
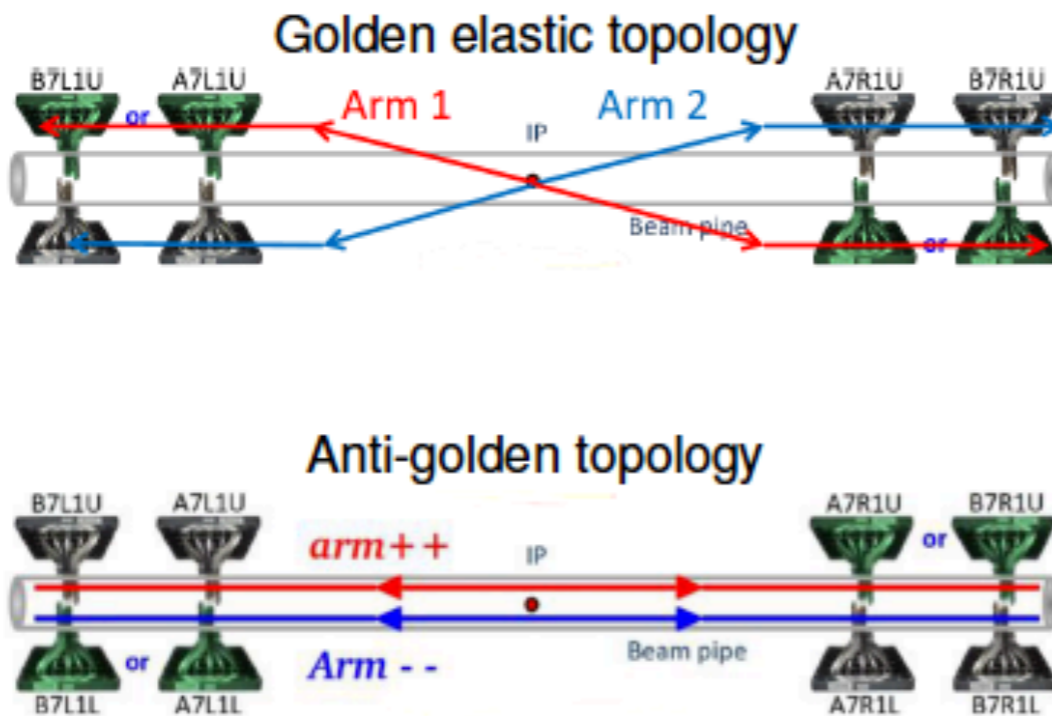

ALFA : acceptance & unfolding

Simulation: Acceptance & unfolding

- The measured t -spectrum is affected by detector resolution and acceptance and must be corrected for these effects.
- PYTHIA8 used as elastic scattering generator.
- Beam transport from IP to ALFA done using MadX.
- Simulated tracks are used to find a reconstructed t .
- Transition matrix used to unfold the raw t -spectrum.

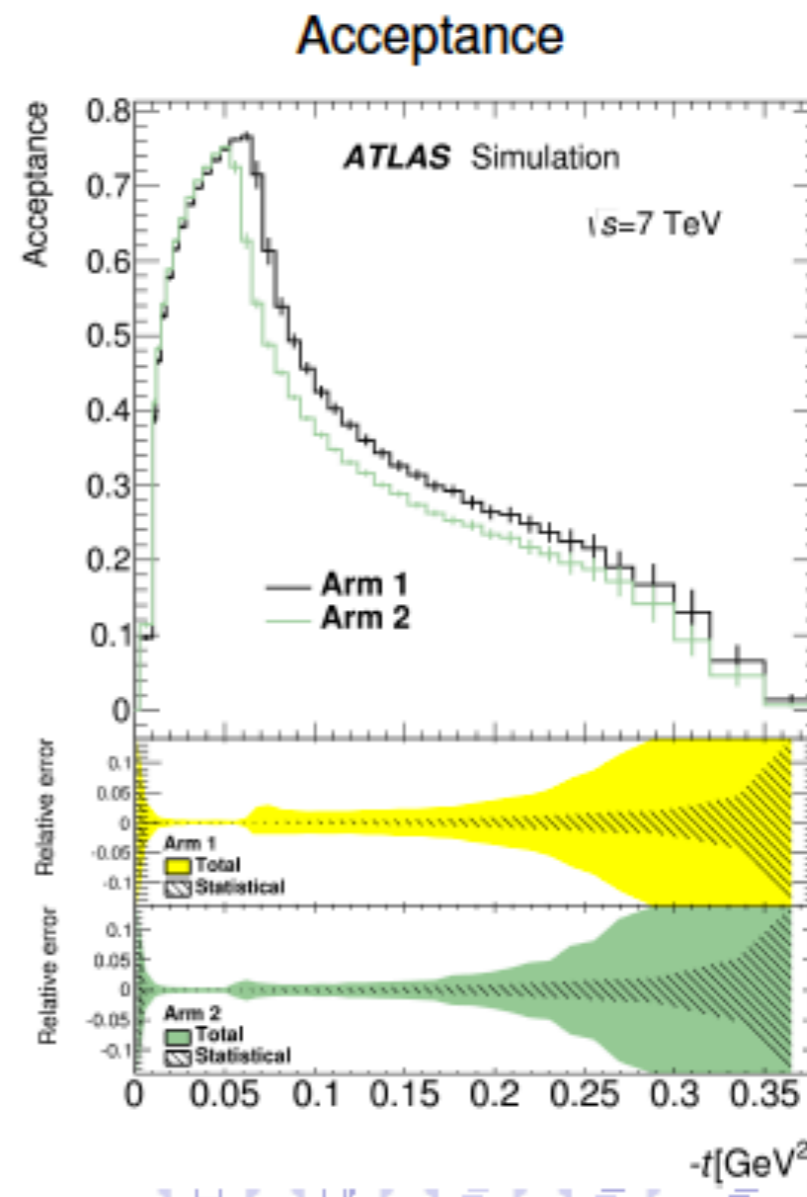
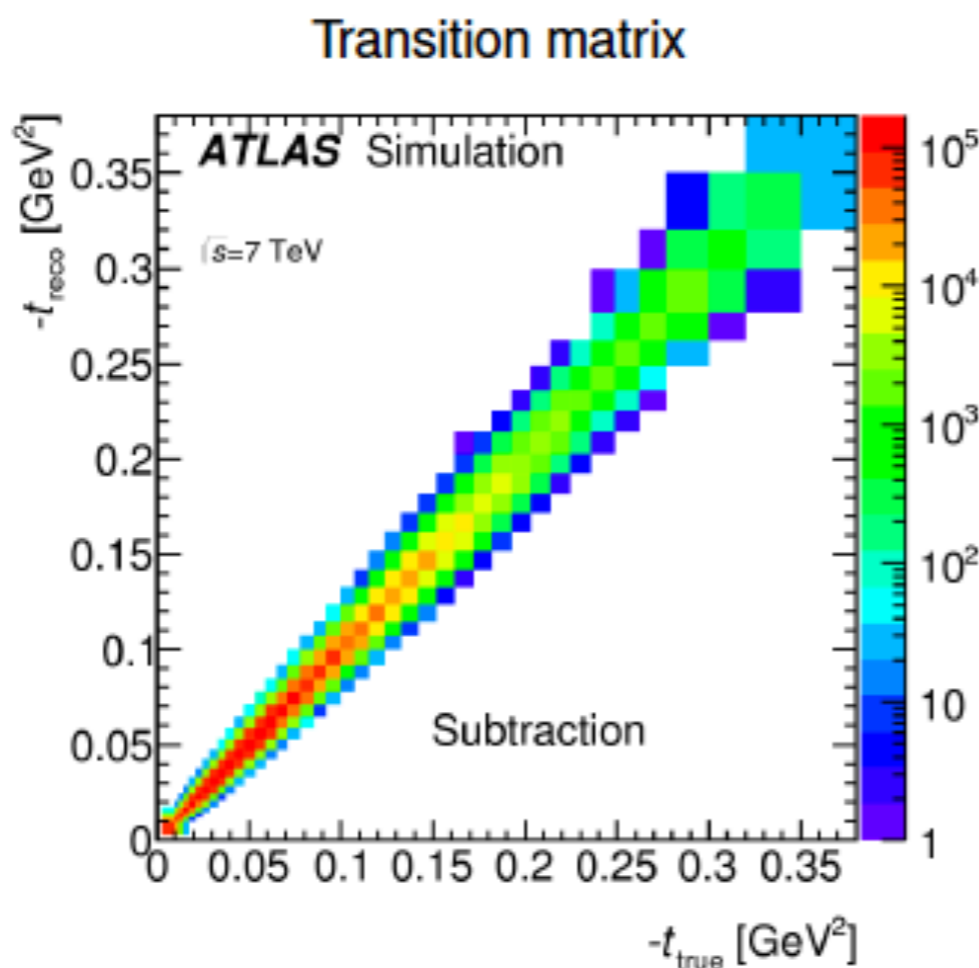

ALFA – Absolute Luminosity for ATLAS

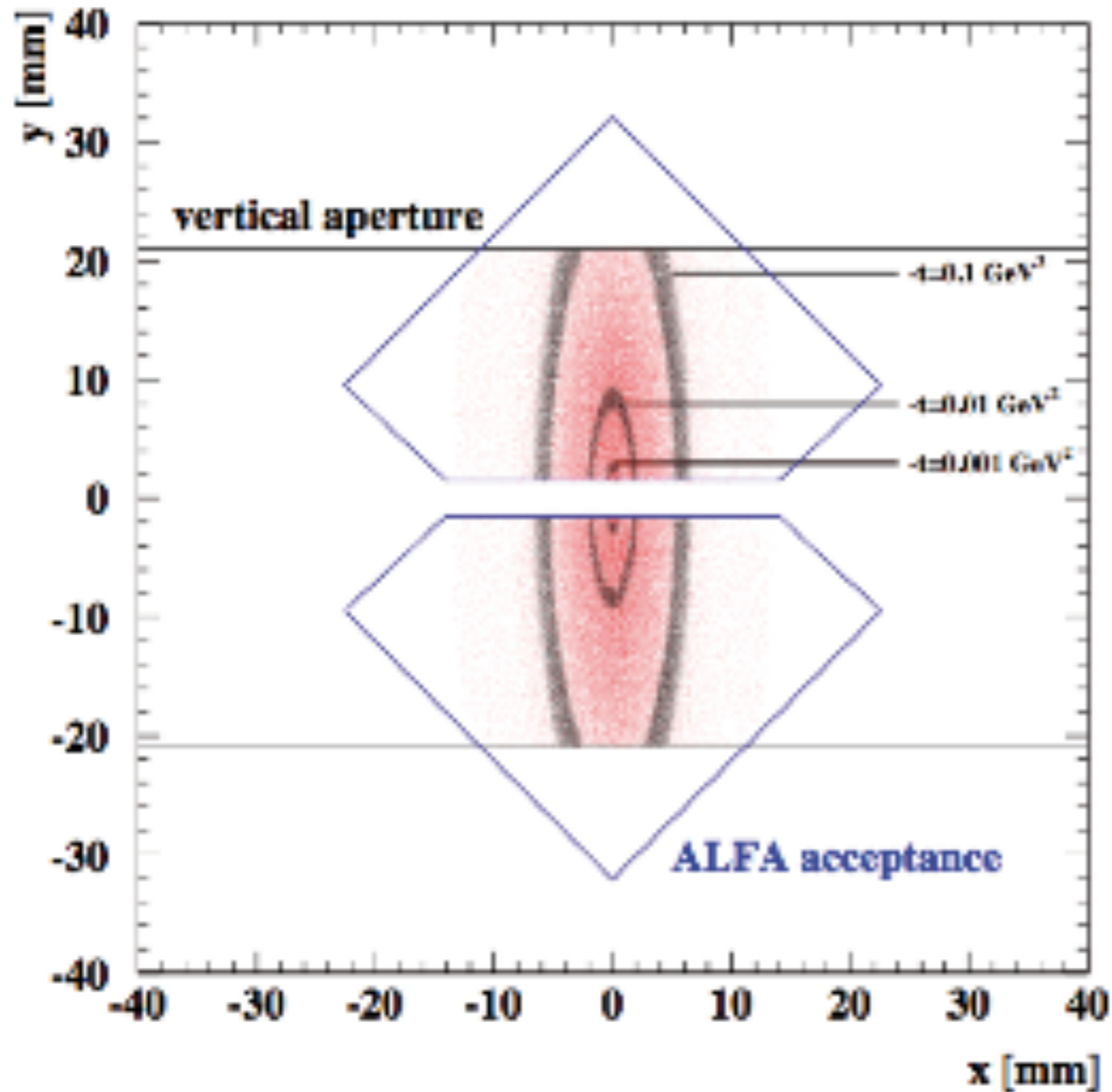

ALFA
Simulated hit distribution

AFP detector

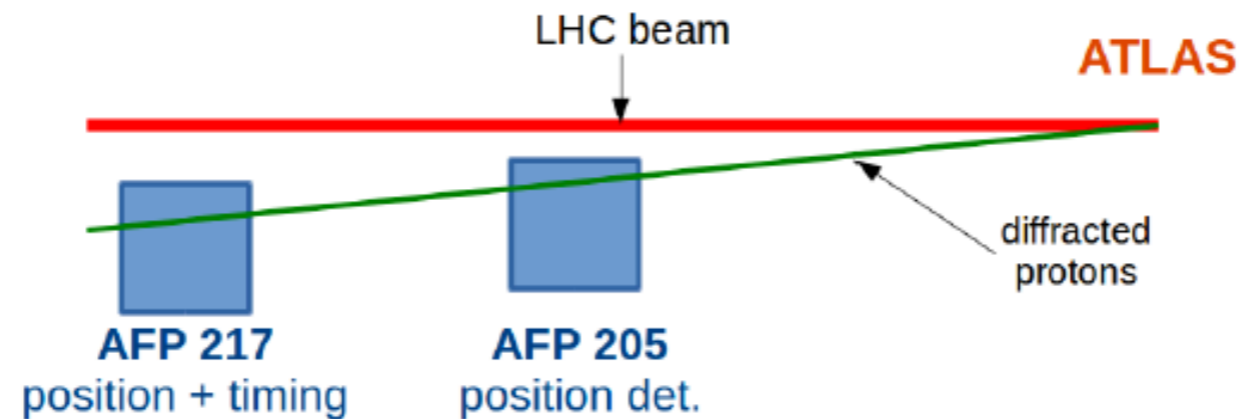

Near station (205 m from ATLAS IP):

- position detectors: 4 layers, staggered.

Far station (217 m from ATLAS IP):

- position detectors,
- ToF detectors: 4 x 4 bars.

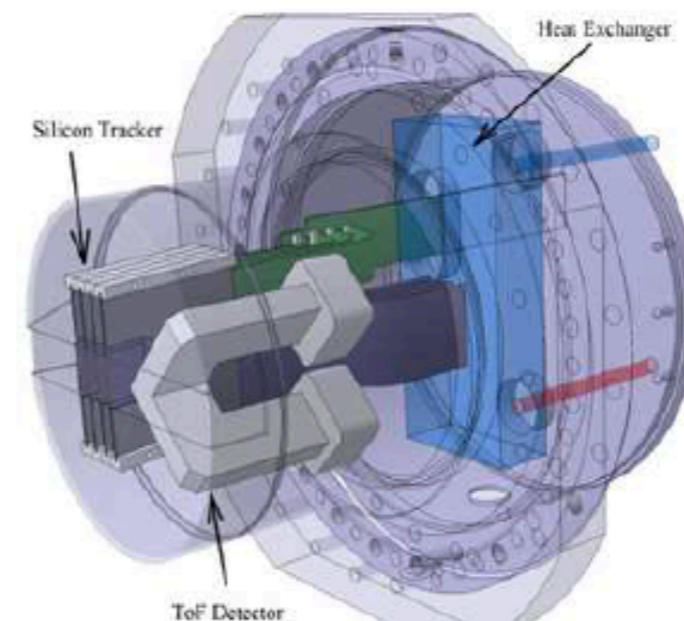

Goals:

- debug the detector; explore the environment close to the LHC beam,
- special runs at low- μ , focusing on high-rate diffractive physics processes,
- staged installation:
 - Winter 2015-2016 shutdown – installation of a single AFP arm with two Roman pot stations, the 0+2 AFP configuration (AFP0+2),
 - Winter 2016-2017 shutdown – installation of the second detector arm.

ATLAS Luminosity detectors

What between VdM scans?

- LUCID
 - Dedicated luminosity monitor ($5.6 < |\eta| < 6.0$)
 - Cherenkov tubes
 - Zero-counting and hit-counting algorithms
- Beam Condition Monitor (BCM)
 - Designed as beam protection system
 - Diamond-based sensor ($|\eta| \sim 4.2$)
 - Zero-counting algorithms
- Silicon detectors
 - Track counting in Pixel and SCT
- Calorimeter currents (bunch-integrating)
 - TileCal PMT currents
 - LAr HV currents: ECC, FCal

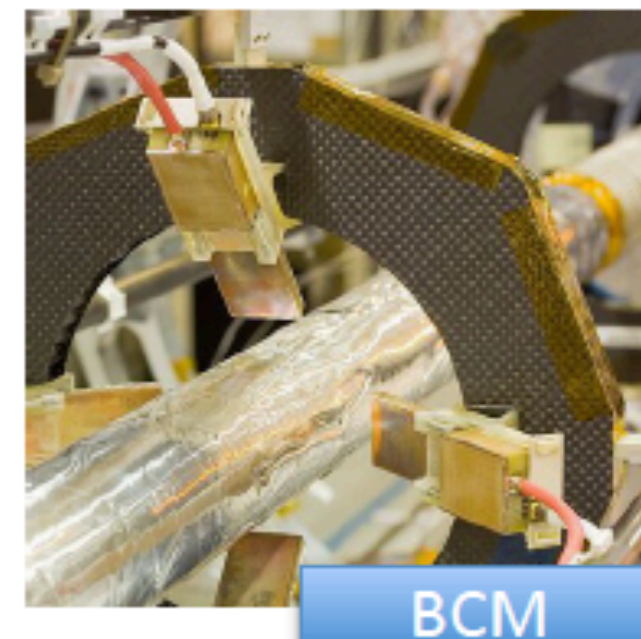
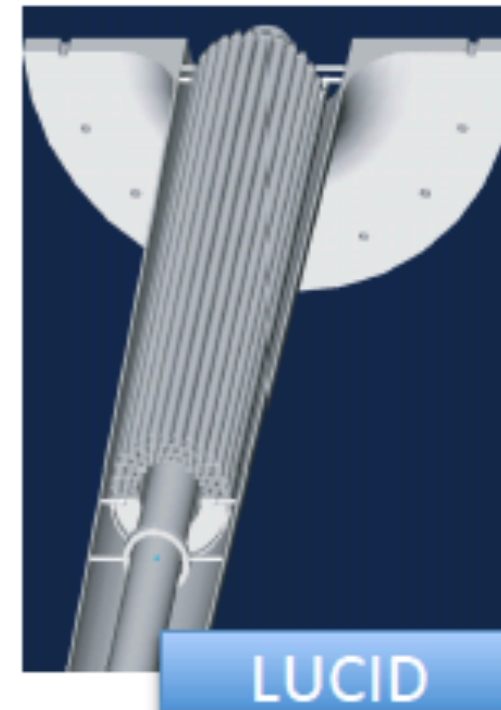

Summary of Luminosity Monitors

Device	Algorithms	Technology	BCID-aware	ACR Desk
<u>BCM</u>	Event counting	Diamond semi-conductors	•	ID
LUCID	Event (Hit) counting Particle flux	Cerenkov quartz windows + PMTs	•	Calo
FCAL	Particle flux	LAr under HV		Calo
MBTS	Event counting	Scintillators + PMTs	•	Trigger
TILE	Particle flux	Scintillator tiles + PMTs		Calo
EMEC	Particle flux	LAr under HV		Calo
TPX	Cluster counting	Hybrid pixel		(TBD)
DBM	Event counting Cluster counting Track counting	Diamond pixels	•	ID

Early LHC Luminosity Measurement

Particle counting:
 Charged Tracks (MBTS)
 Calorimeter deposits (LAR)
 [Normalization via Monte Carlo]

Forward Particles (LUCID)
 [Relative Method; normalization to MBTS/LAr]

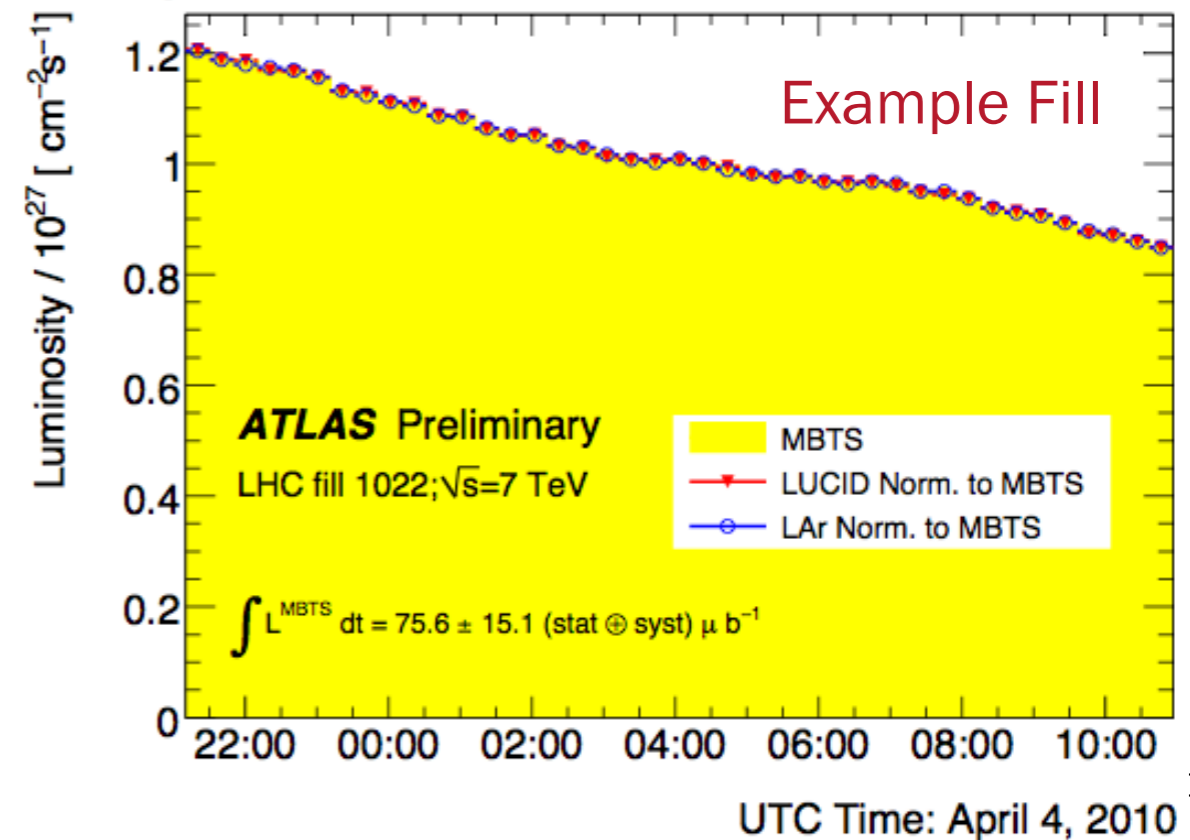
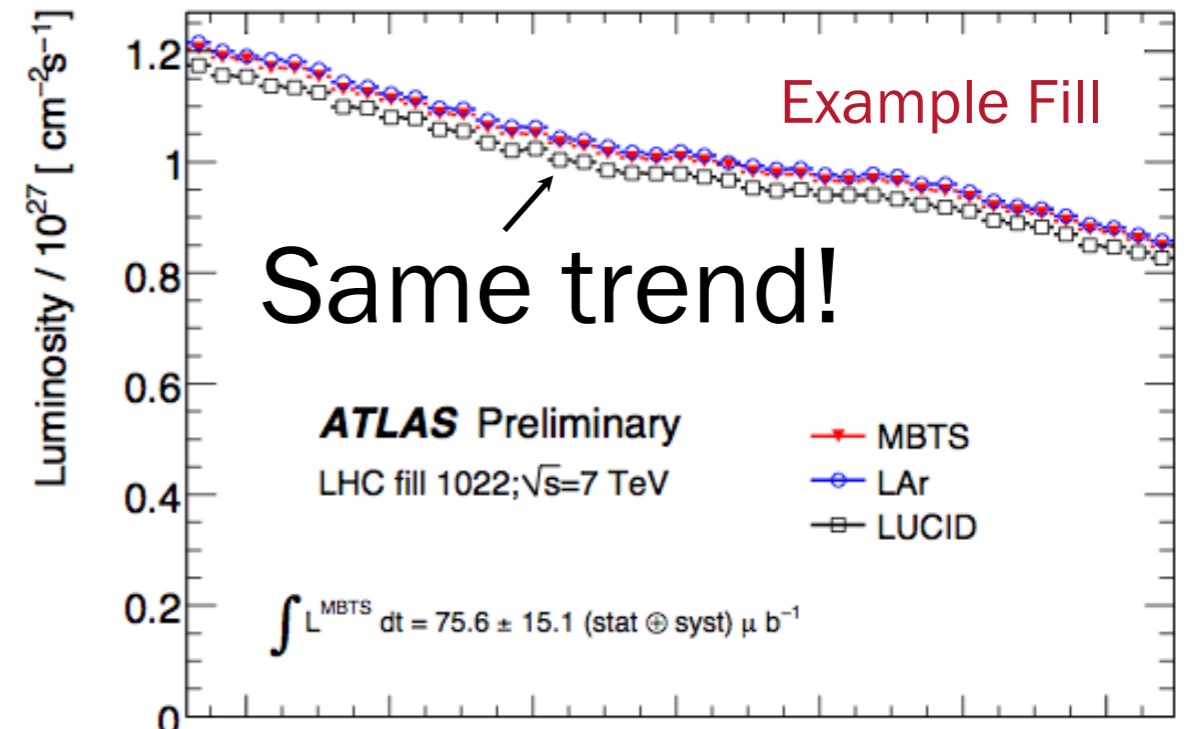
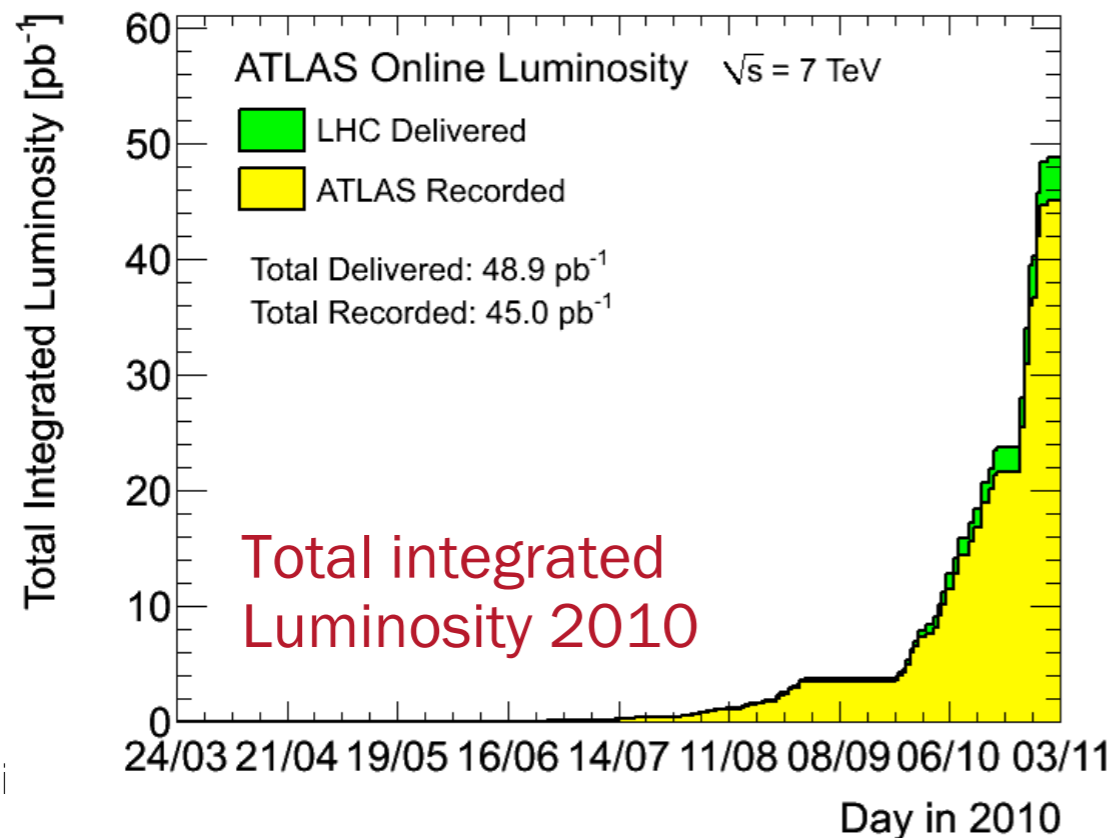

ATLAS Forward Region

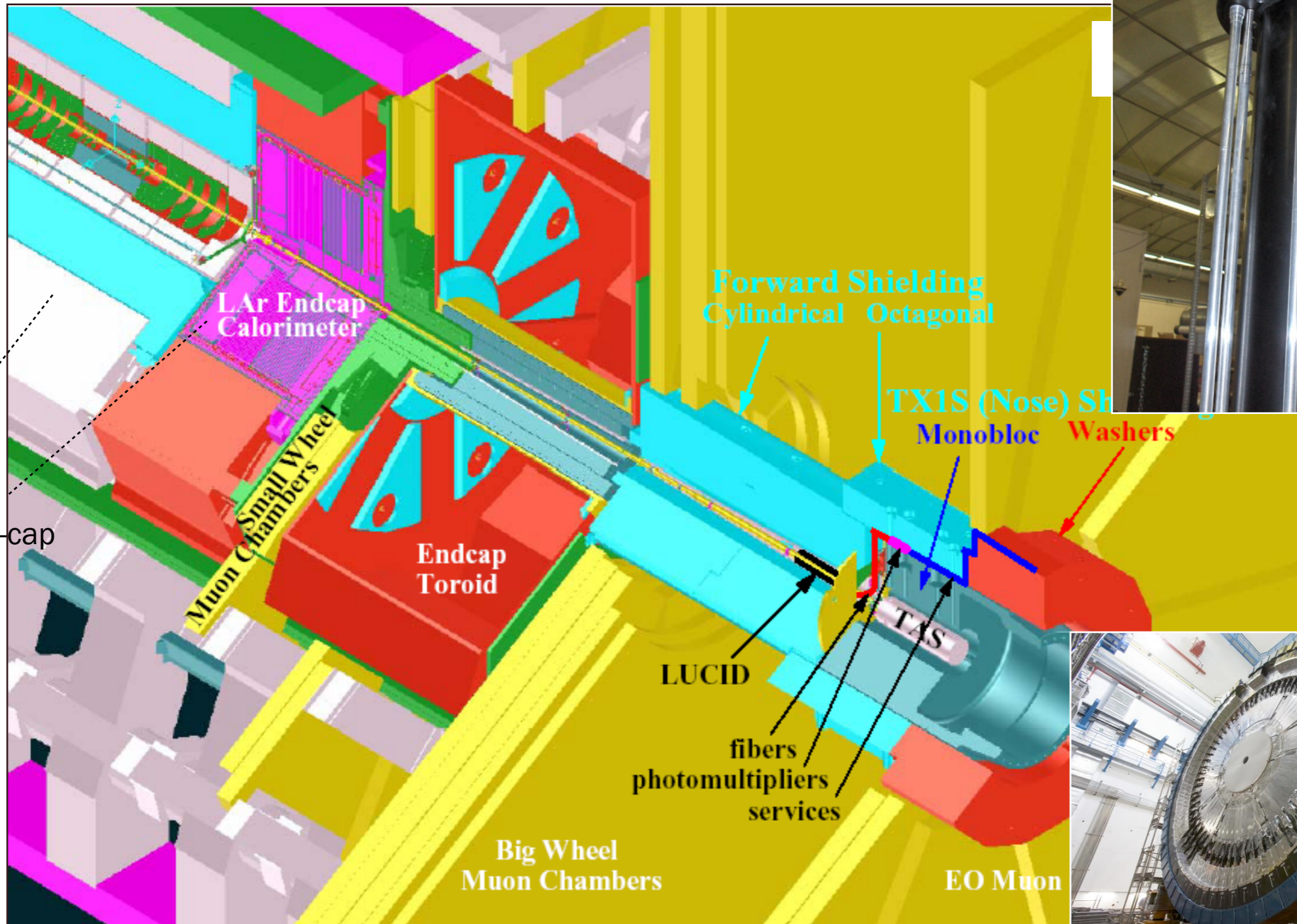

LUCID vessel

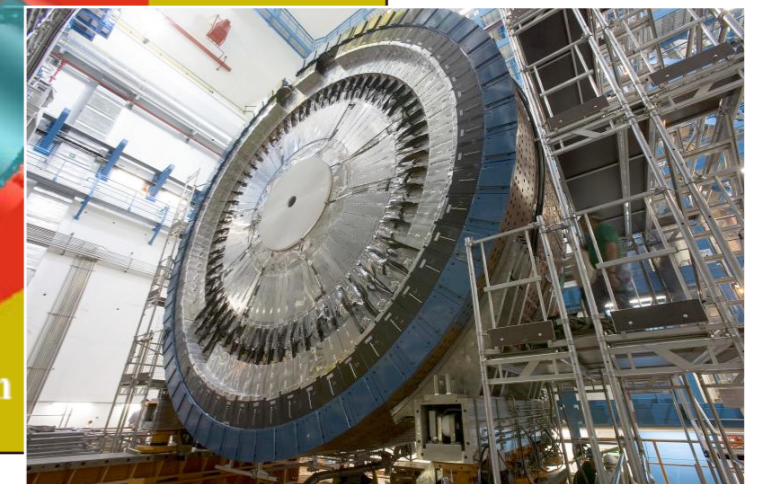

courtesy J.Pinhold

LUCID

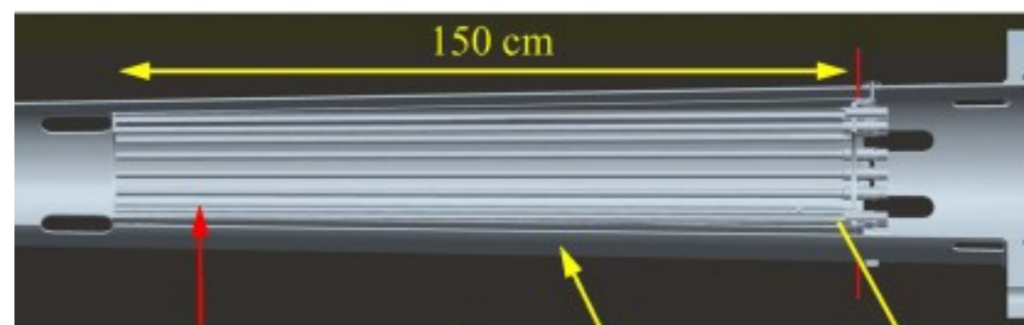

LUCID

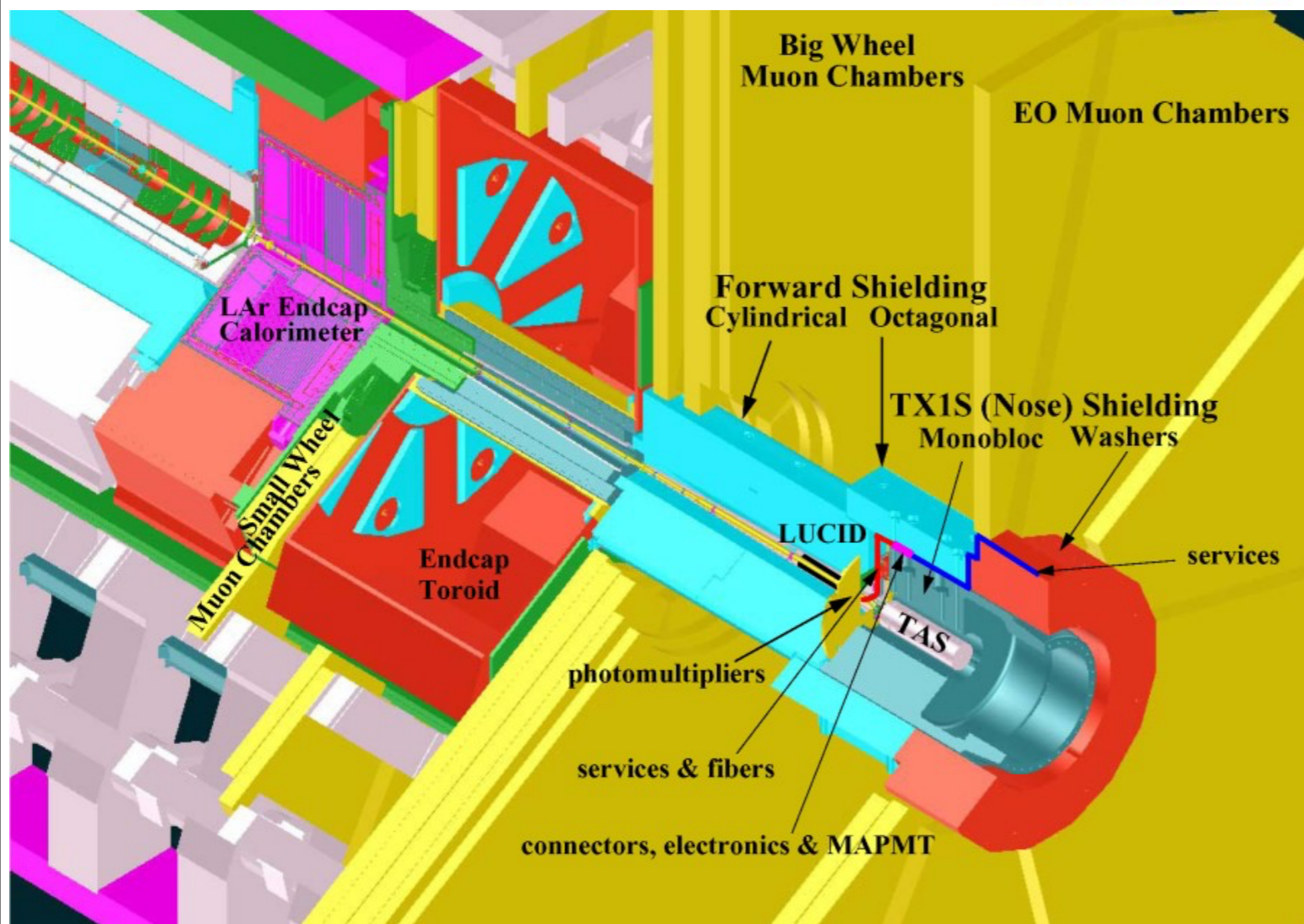
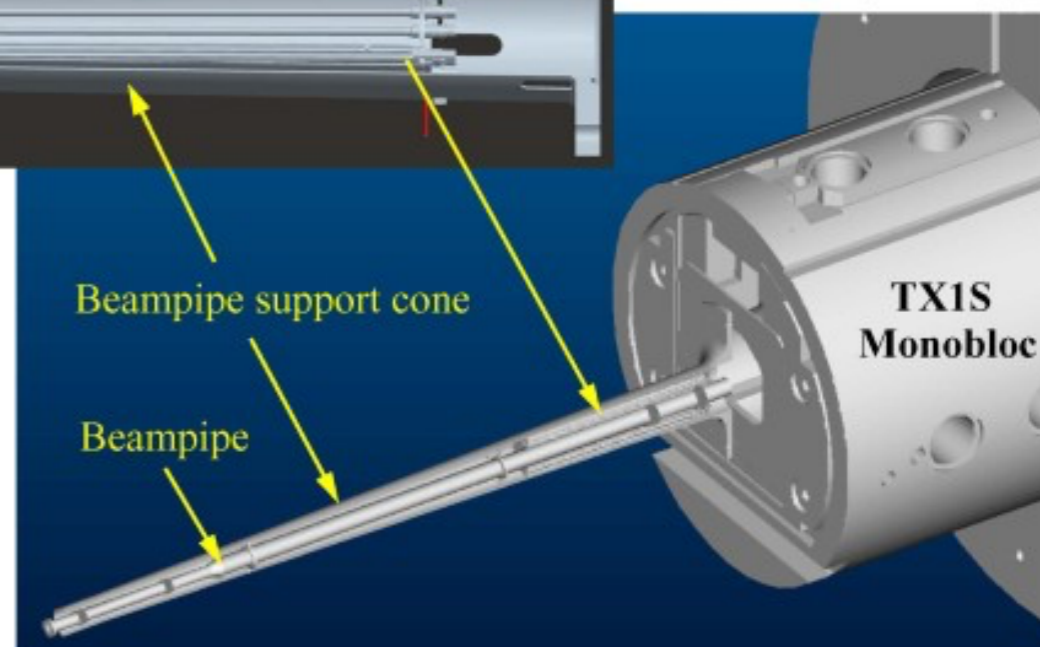

LUCID

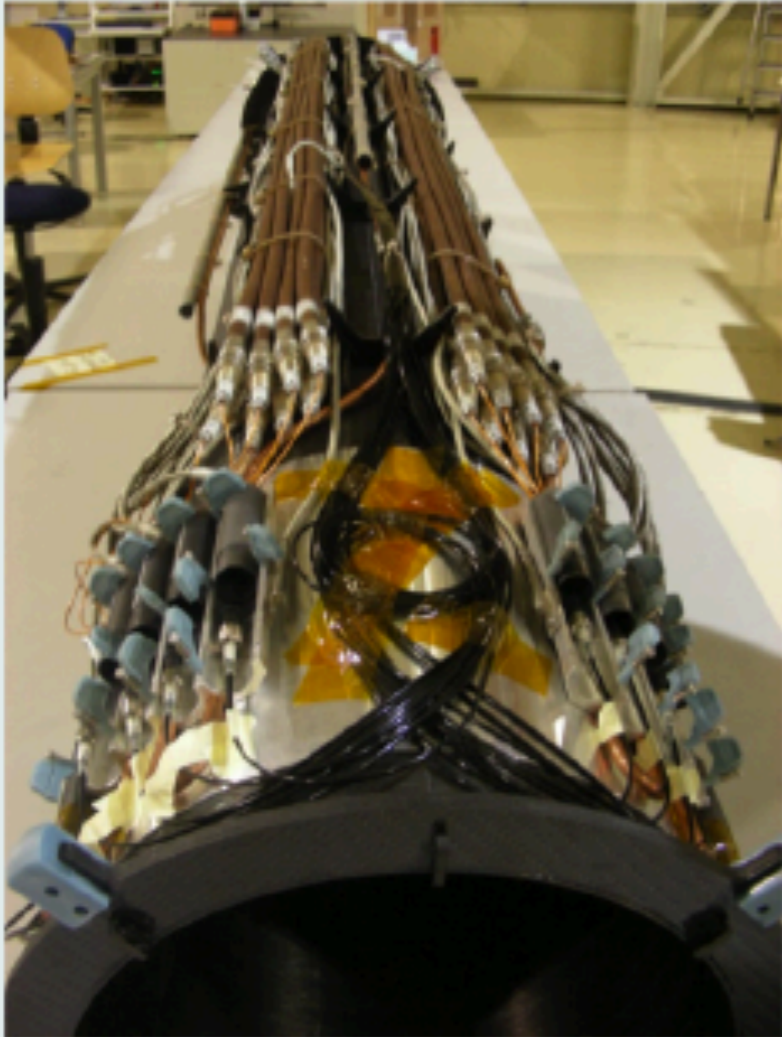

- **Main role:** Luminosity Measurement.
- **Technology:** Cherenkov emitting quartz windows connect to PMTs.
- **Configuration:** 16 PMTs on each side of ATLAS, 17m from the IP.
- **Highlights:** Fast and high redundancy (each PMT read out individually). Capable of event and hit counting as well as and particle flux measurements.

- **Sampling/Time resolution:** Every BCID.
- Major upgrades for Run II: new calibration, more redundant measurements, reduced acceptance.

Comparison among different monitors

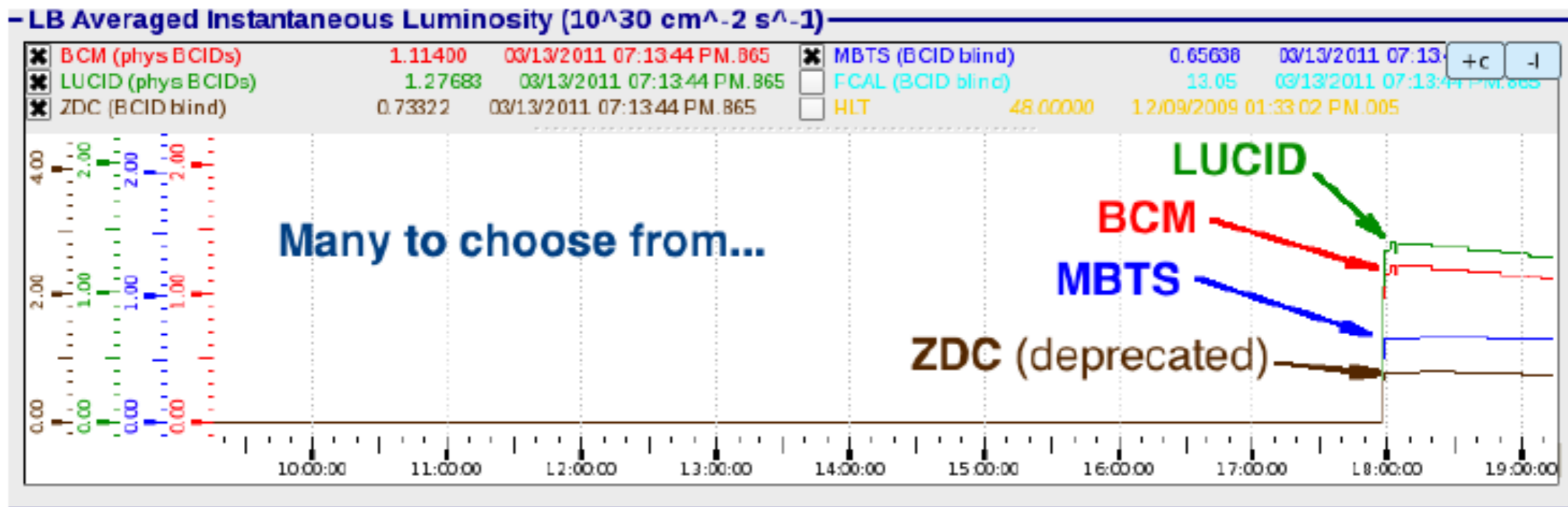

Backup slides

Methods for Luminosity Measurement - 1

The luminosity \mathcal{L} of a pp collider can be expressed as

$$\mathcal{L} = \frac{R_{\text{inel}}}{\sigma_{\text{inel}}}$$

\mathcal{L} instantaneous luminosity
 \mathcal{L}_{int} integrated luminosity

where R_{inel} is the rate of inelastic collisions and σ_{inel} is the pp inelastic cross-section. For a storage ring, operating at a revolution frequency f_r and with n_b bunch pairs colliding per revolution, this expression can be rewritten as

$$\mathcal{L} = \frac{\mu n_b f_r}{\sigma_{\text{inel}}}$$

where μ is the average number of inelastic interactions per bunch crossing.

ATLAS **monitors** the delivered luminosity by measuring the observed interaction rate per crossing, μ_{vis} , independently with a variety of detectors and using several different algorithms. The luminosity can then be written as

$$\mathcal{L} = \frac{\mu_{\text{vis}} n_b f_r}{\sigma_{\text{vis}}}$$

Calorimeters

Tile Calorimeter

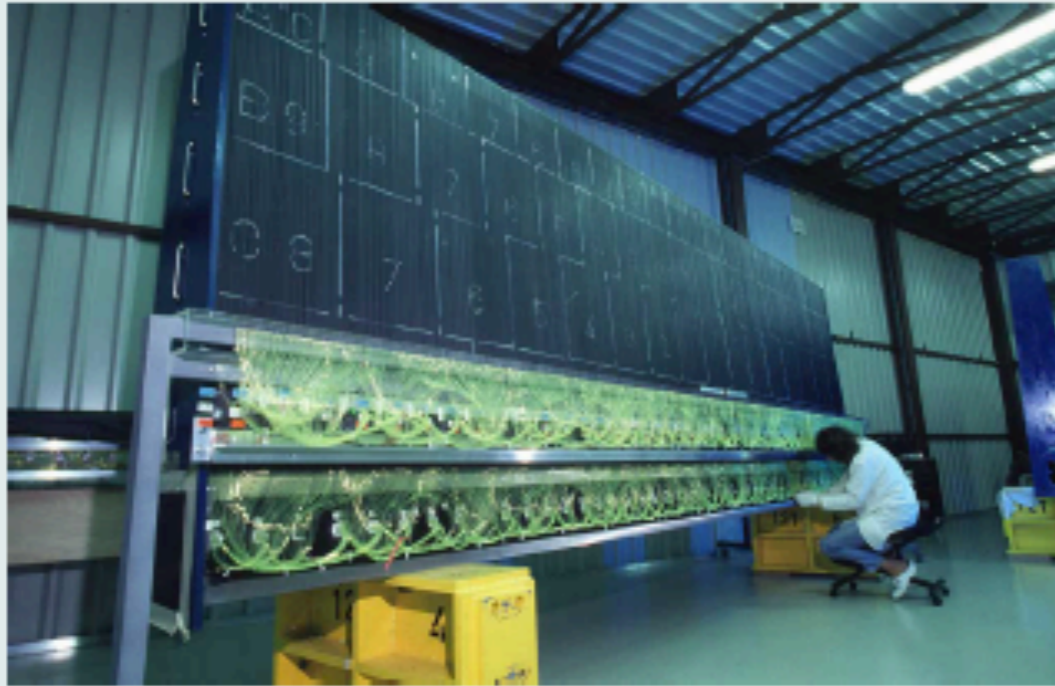

- **Technology:** Scintillator tiles connected to PMTs.
- **Highlights:** Particle flux measurement, far from beamline.
- **Sampling/Time resolution:** bunch-integrated response every few seconds.

EMEC and FCal



- **Technology:** Liquid argon gaps between electrodes under HV.
- **Highlights:** Particle flux measurement, closer to beamline.
- **Sampling/Time resolution:** bunch-integrated response every few seconds.

Methods for Luminosity Measurement - 2

Where $\sigma_{\text{vis}} = \varepsilon\sigma_{\text{inel}}$ is the total inelastic cross-section multiplied by the efficiency ε of the detector and efficiency and similarly μ_{vis} . Since μ_{vis} is an observable quantity the calibration of the luminosity scale is equivalent to determining the visible cross-section.

$$\mathcal{L} = \frac{\mu_{\text{vis}} n_b f_r}{\sigma_{\text{vis}}}$$

Methods:

- Event counting algorithms, count events satisfying selection criteria. In the limit $\mu_{\text{vis}} \ll 1$ then $\mu_{\text{vis}} \approx N/N_{\text{BC}}$ where N selected events, N_{BC} number bunch crossings. In the limit case in which all bunch crossings contain one event passing criteria, then event counting algorithms contain no information about the interaction rate
- Hit counting algorithm, rather than counting events count hits above some threshold. This approach is much more robust and saturates much more slowly wrt previous method

Methods for Luminosity Measurement - 3

The calibration of σ_{vis} is performed using a dedicated method based on beam-separation scans, called van der Meer (vdM) method. The delivered luminosity can be written in terms of accelerator parameters as

$$\mathcal{L} = \frac{n_b f_{\text{r}} n_1 n_2}{2\pi \Sigma_x \Sigma_y}$$

Where n_1 and n_2 are the bunch populations (protons per bunch) and $\Sigma_x \Sigma_y$ are the beam widths in the x,y direction. More in the following.

Van der Meer scan basics

- The key idea of the VdM scan is to relate the overlap integral to the rate integral [12]:

$$\Omega_x = \frac{\boxed{R_x(0)} \text{ Rate measured by detector}}{\int \boxed{R_x(\delta)} d\delta \text{ Beam separation}}$$

- Defining the convolved beam size Σ_x as

$$\Sigma_x = \frac{1}{\sqrt{2\pi}} \frac{1}{\Omega_x}$$

the luminosity becomes

$$\mathcal{L} = \frac{n_b f_r n_1 n_2}{2\pi \boxed{\Sigma_x \Sigma_y} \text{ Convolved beam sizes}}$$

$$\sigma_{vis} = \boxed{\mu_{vis}^{Max}} \frac{2\pi \boxed{\Sigma_x \Sigma_y}}{\boxed{n_1 n_2}}$$

Detector dependent \rightarrow μ_{vis}^{Max}
 Measured in vdm scan \rightarrow μ_{vis}^{Max}
 Detector independent \rightarrow $\Sigma_x \Sigma_y$
 Measured by beam instrumentation \rightarrow $n_1 n_2$

