

Introduction to trigger concepts

F.Pastore (Royal Holloway Univ. of London)

francesca.pastore@cern.ch

The data deluge

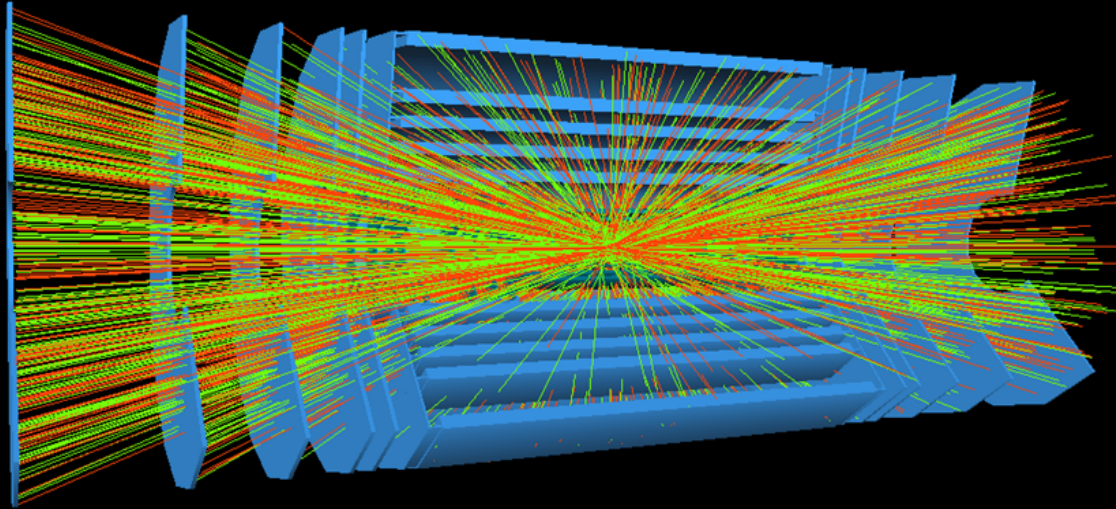

- In many systems, like particle physics or astronomy experiments, to store all the possibly relevant data provided by the sensors is UNREALISTIC and often becomes also UNDESIRABLE
- Three approaches are possible:
 - Reduced amount of data (packing and/or filtering) → **Trigger!**
 - Faster data transmission and processing
 - Both!

The trigger concept

Digital signal saying YES or NO

- ▶ It's like deciding to take a very good photo during your holidays:
 - ▶ **click the button** to open the bolt and let the sensors operate
 - ▶ take the photo only when you think the **subjects** are ready
 - ▶ **focus** the image
 - ▶ only if there is enough **light** for your lenses (or add a flash light)
 - ▶ only if your hand is not **shaking**



- The trigger starts the photo process
- First identify the interesting event
- Ensure the sensitivity to parameters
- Ensure a good synchronisation

Trigger concept in HEP

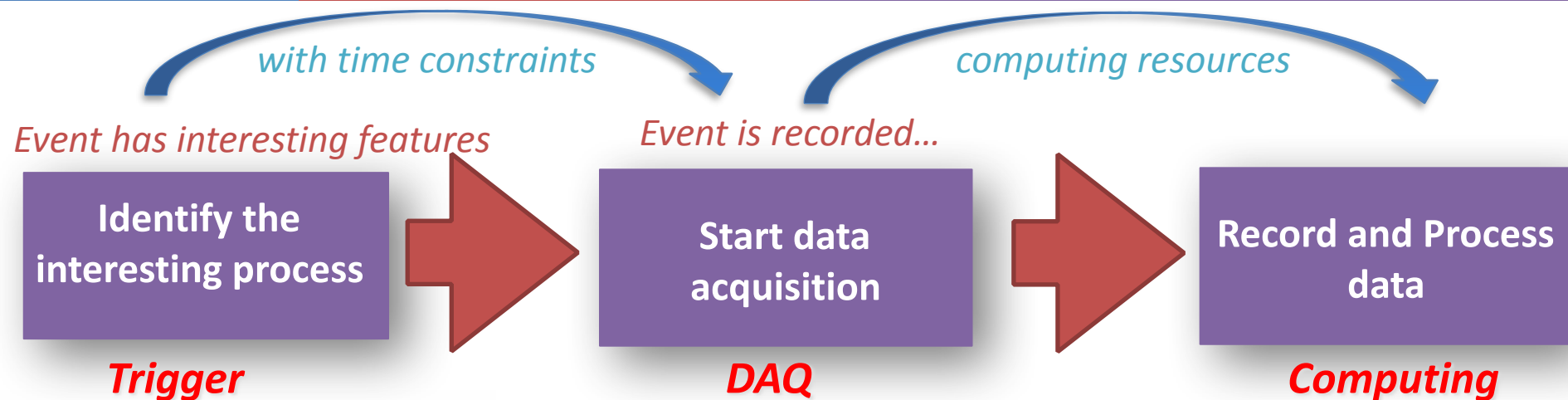

The constrain between trigger and DAQ rate is the storage and the offline computing capabilities

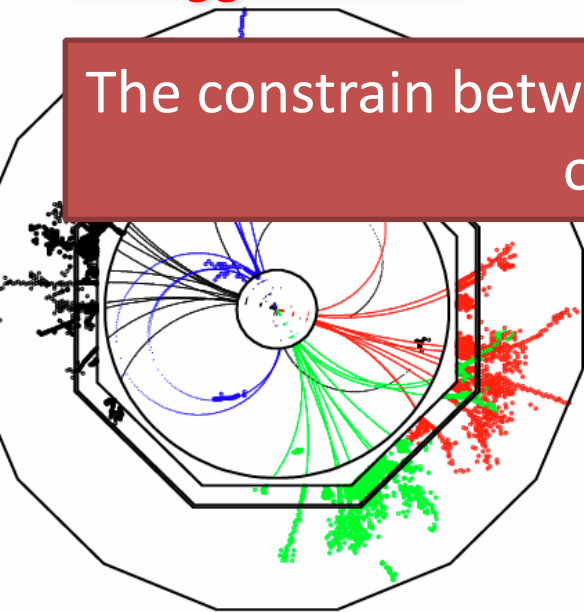

- ▶ What is “interesting”?
 - ▶ Define what is signal and what is background
- ▶ Which is the balance between Trigger and DAQ resources?
 - ▶ Define the maximum allowed rate
- ▶ How fast the selection must be?
 - ▶ Define the maximum allowed processing time

Which is the expected trigger rate?

The expected event rate is derived from the physics process (x-section times Luminosity)

$$R = \sigma_{in} \times L$$

LHC: the trigger challenge!

Total non-diffractive p-p cross section is 70 mb

Total trigger rate is ~ GHz!!!

Huge range of cross-sections and production rates at design:

Beauty (0.7 mb)	– 1000 Hz
W/Z (200/60 nb)	– 100 Hz
Top (0.8 nb)	– 10 Hz
Higgs - 125 GeV (30 pb)	– 0.1 Hz

$$\frac{\sigma_{tot}}{\sigma_{H(500\text{GeV})}} \approx \frac{100\text{ mb}}{1\text{ pb}} \approx 10^{11}$$

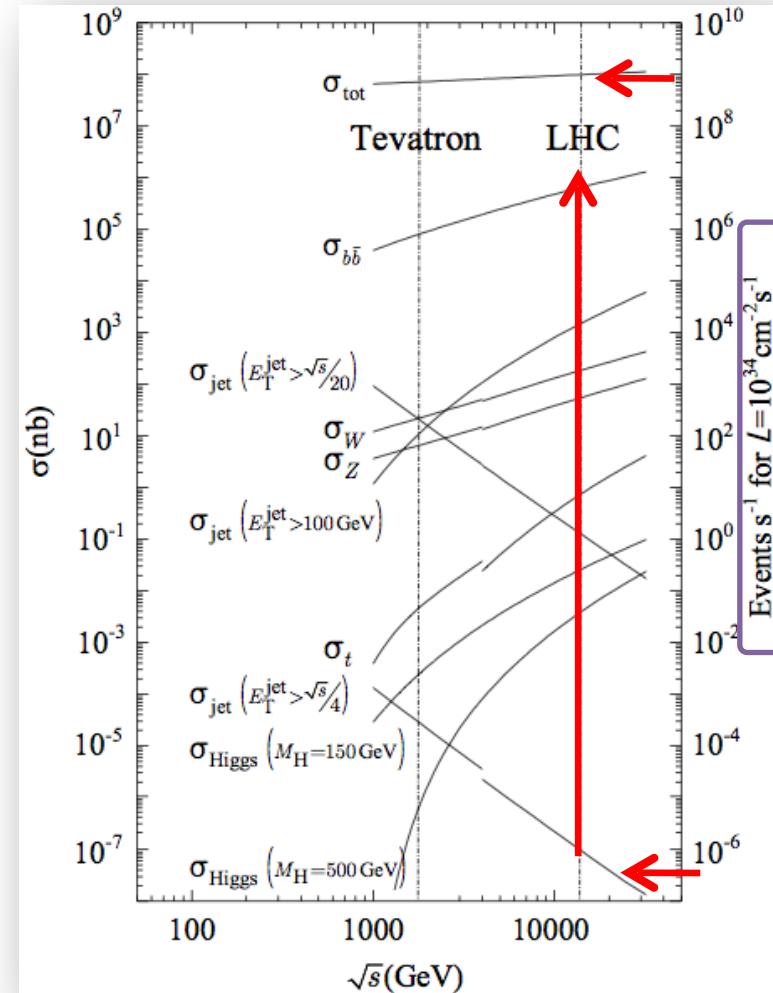

Background discrimination is crucial

- The final rate is often dominated by not interesting physics
- The trigger accepts events with features **similar** to the signal

As easy as....



- ▶ *Crucial for selecting specific features within widely extended systems*
- ▶ *With limited amount of time*
- ▶ *With limited resources*

Which is a good trigger for the Higgs Boson?

All tracks

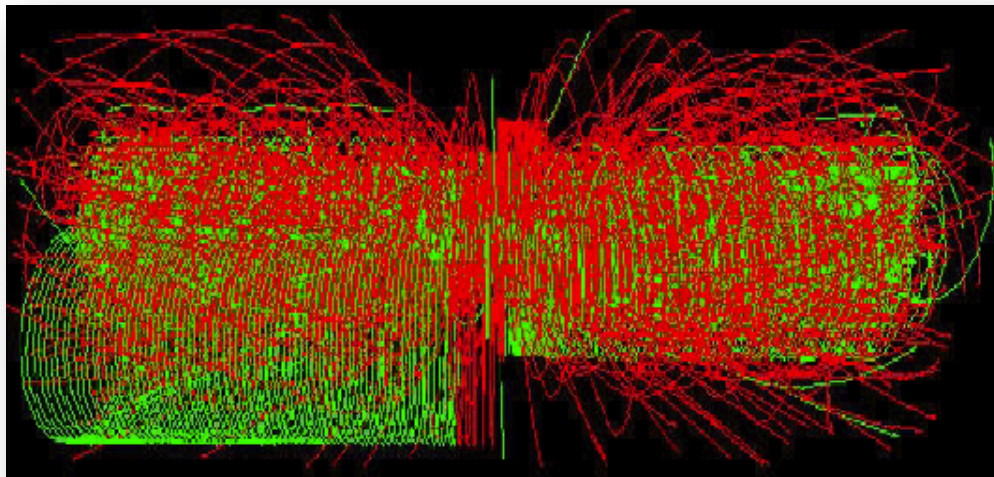

+30 MinBias

Only high-pt tracks

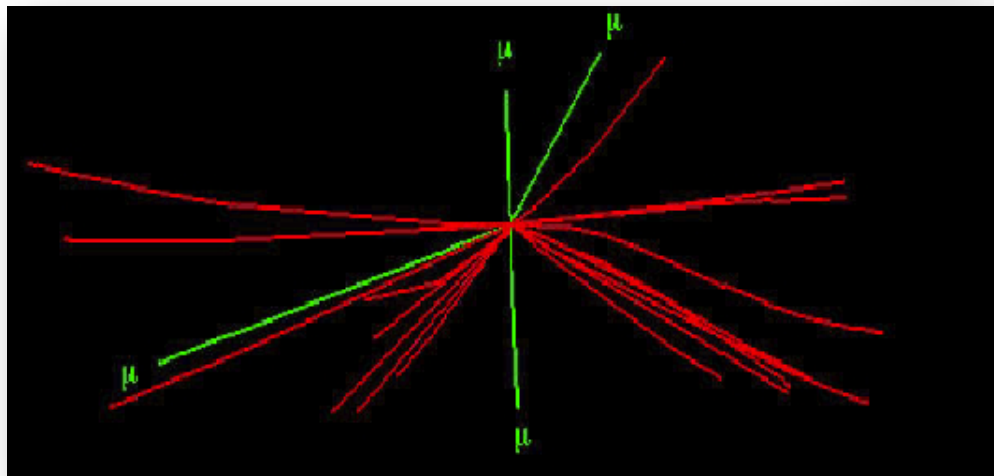

Higgs \rightarrow 4μ

Simulate the **signal** events
Higgs \rightarrow 4μ as it appears at the
LHC (with soft collisions coming
from the p-p interactions)



The trigger signature is given by
high momentum muons
(at least one)

Not always need to reduce the rate

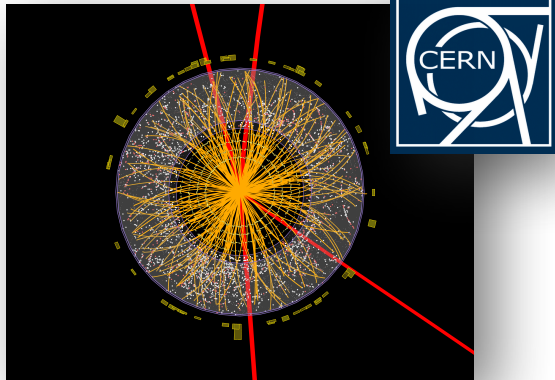

▶ LHC – ATLAS

- ▶ Project started in 1996
- ▶ Technology chosen in 2000
- ▶ Start data-taking 2008

- ▶ Full p-p collision rate: 40 MHz
- ▶ Average event size: 1.5 MB
- ▶ **Full data rate: ~60 PB/s**

- ▶ Defined physics signal
- ▶ Complex trigger reduces 7 orders of magnitudes to 200 Hz

- ▶ **Affordable DAQ rate: ~300 MB/s -> 200 Hz**
- ▶ **Data distribution (GRID)**



▶ SKA (Square Km Array)

- ▶ Project started in 2011
- ▶ Technologies under evaluation now
- ▶ Start operations in 2024

- ▶ Photograph the sky continuously
- ▶ 1.12 PB/s of photos collected

- ▶ EXASCALE system 10^{18} operations for correlation and imaging
- ▶ **Simple correlator : 10 TB/s**
- ▶ **Total Internet Traffic \approx 8 TB/s in 2010**

- ▶ Required large computing power
- ▶ Big-data and cloud-computing drive market

Which is the best filter?



Trigger requirements

Trigger parameters to easily distinguish

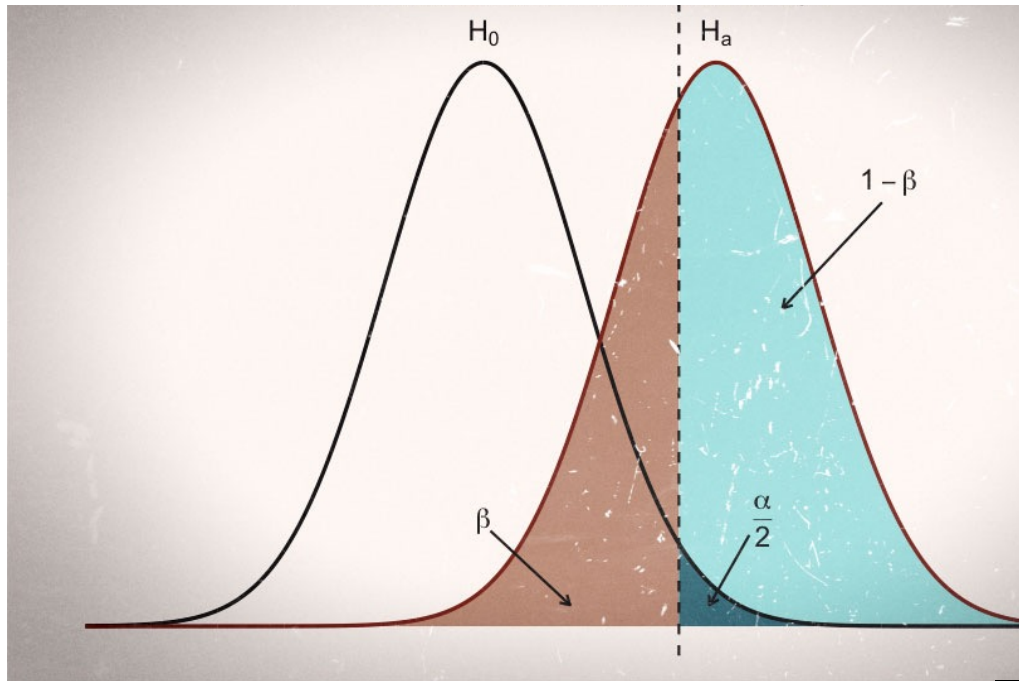

Testing A
Hypothesis

- Remember the Higgs discovery:
 - high p_T muons for signal
 - low p_T muons are background
- Which p_T threshold then?

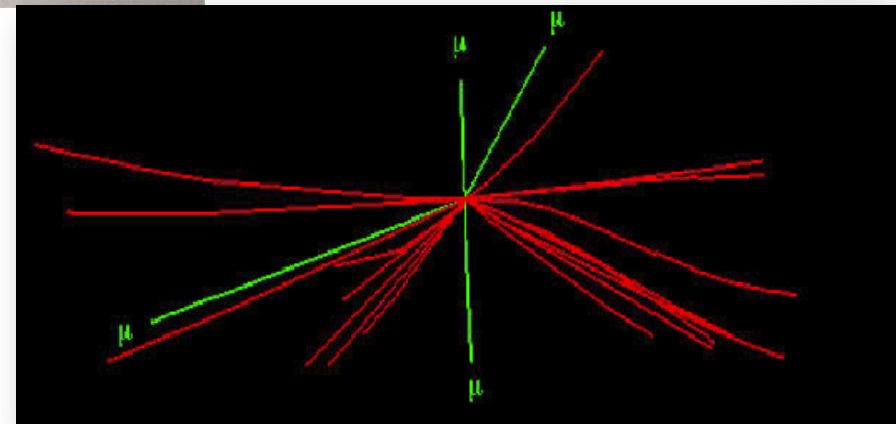

Higgs \rightarrow 4μ

Requirement 1: *high signal efficiency*

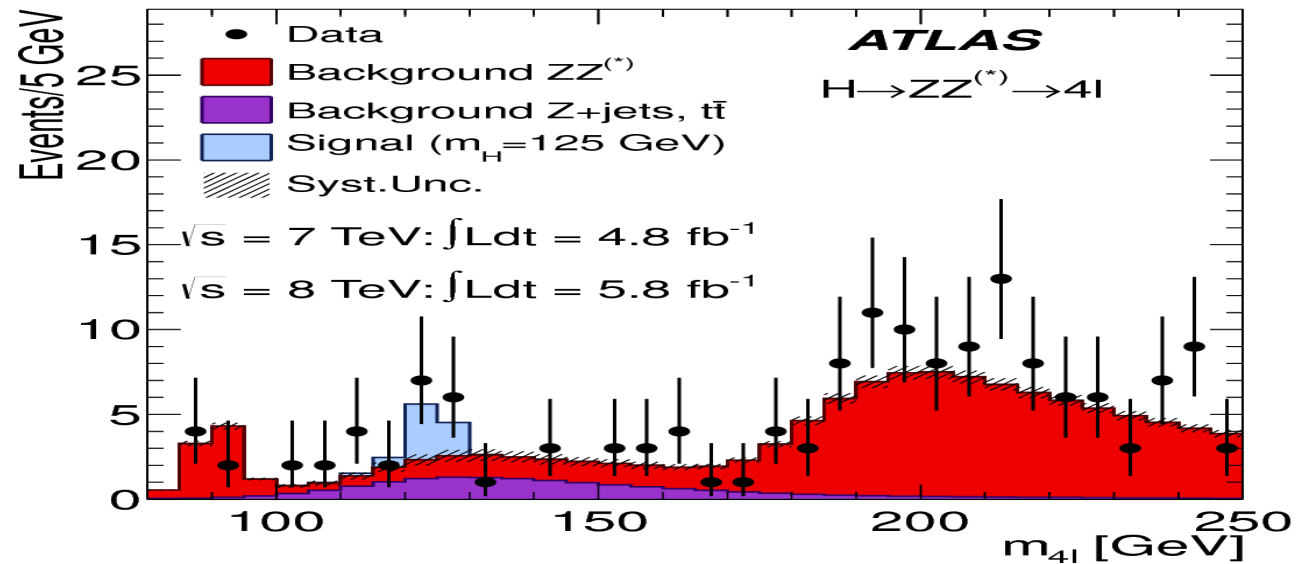

4-leptons invariant mass,
selected events for
 $H \rightarrow ZZ \rightarrow 4l$

muon p_T

background

signal + unknown

$$\epsilon_{\text{trigger}} = N_{\text{good (accepted)}} / N_{\text{good (produced/expected)}}$$

- ▶ Maximise the acceptance
 - ▶ Good design of the architecture
- ▶ Optimise the selection
 - ▶ The selection must be optimised on the signal

Requirement 2: *high background rejection*

*Inclusive single muon
 p_T spectrum*

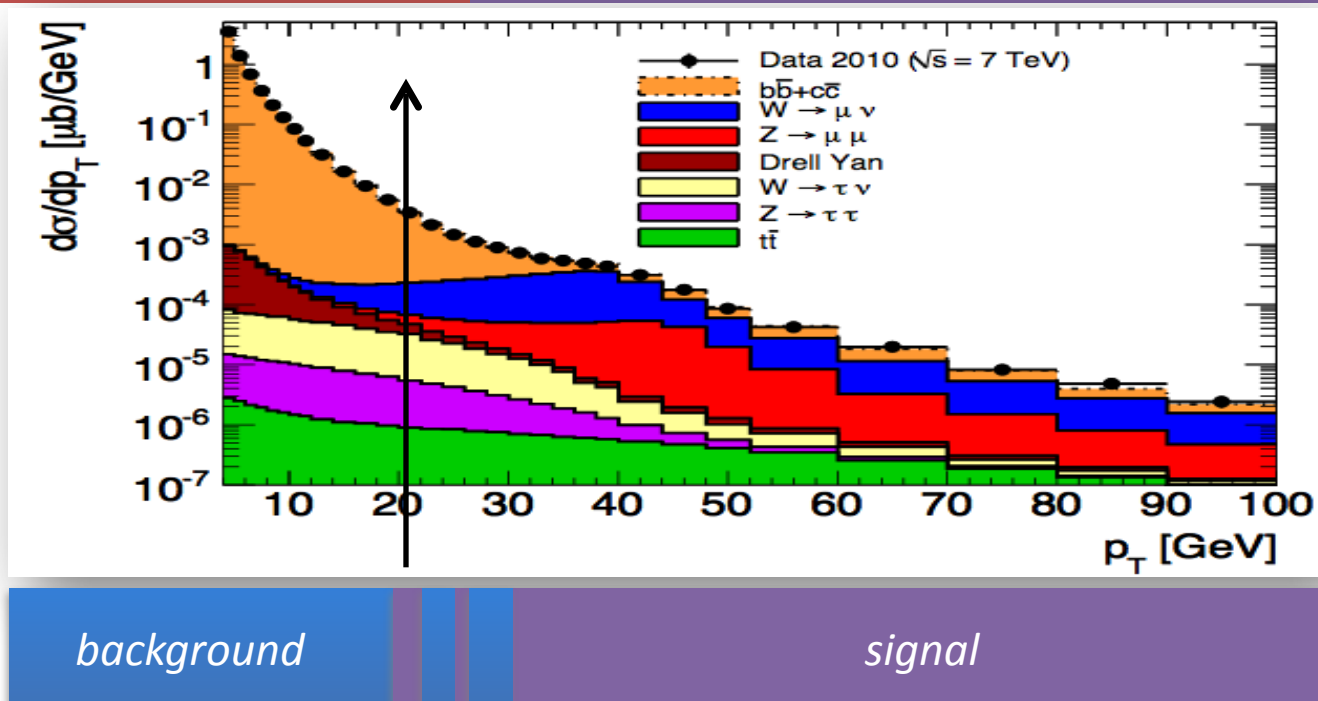

$$\text{Rej}_{\text{bkg}} = 1 - N_{\text{bad(accepted)}} / N_{\text{bad (produced/expected)}}$$

▶ Rate control capability

- ▶ Instrumental or physics background
 - ▶ Identify **characteristics** that can suppress the main background
 - ▶ Demonstrate solid **understanding** of background rate and shapes
- ▶ Backgrounds sometimes are known with great uncertainties
 - ▶ make your trigger **flexible and robust**

...with compromises?

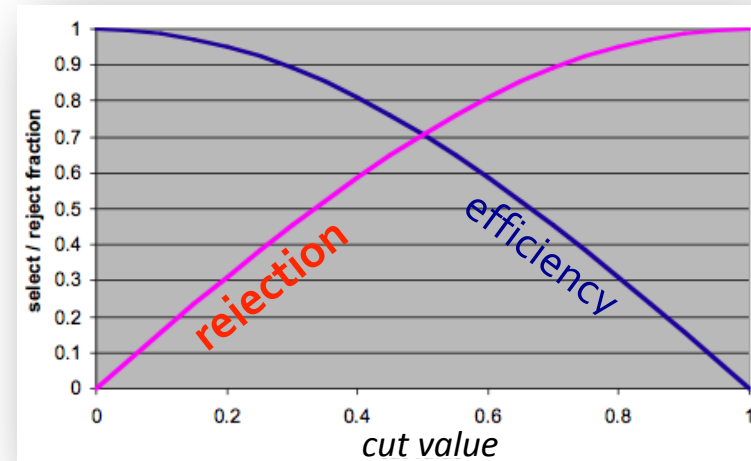
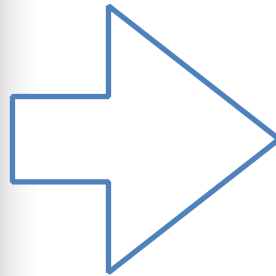
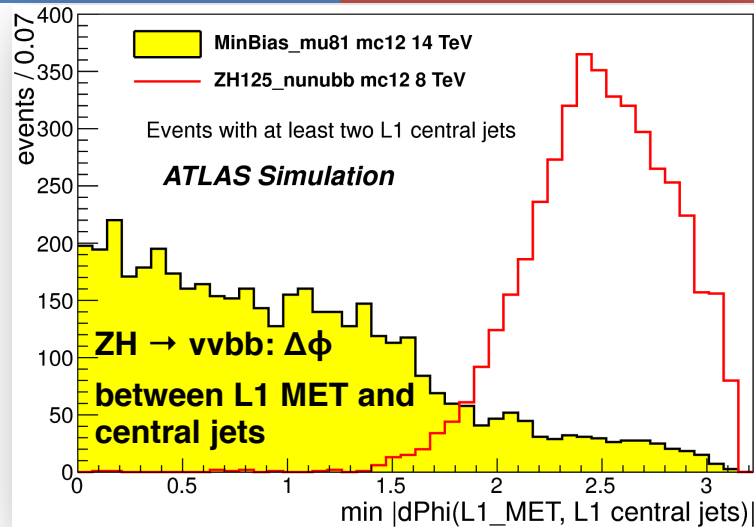

- ▶ If any of the two requirements cannot be realised, **refine your selection!**
 - ▶ Change the parameters, eventually with more complex ones, but still remain **fast!**
 - ▶ With additional compromises (number of processors working in parallel and fastness of the algorithms)

- ▶ **Whatever criteria you choose, discarded events are lost for ever!**
- ▶ So, check that your trigger system:
 - ▶ **Is not biasing your measurement**
 - ▶ Discovery experiments: use inclusive selections
 - ▶ Precision experiments: use well known selections
 - ▶ **Is reliable**
 - ▶ Do you trust your trigger? If not, add control samples!

Trigger efficiency is a parameter of your measurement

$$BR(\text{Signal}) = \frac{(N_{\text{candidates}} - N_{\text{bg}})}{\alpha \cdot \epsilon_{\text{total}} \cdot \sigma_{Bs} \cdot \int L dt}$$

$$\alpha \cdot \epsilon_{\text{total}} = \alpha \cdot \epsilon_{\text{Tracking}} \cdot \epsilon_{\text{Reco}} \cdot \epsilon_{\text{L1-Trig}} \cdot \epsilon_{\text{L2-Trig}} \cdot \epsilon_{\text{L3-Trig}} \cdot \epsilon_{\text{vertex}} \cdot \epsilon_{\text{analysis}}$$

Trigger efficiency must be **precisely known**, since it enters in the calculation of the cross-sections

For some precise measurements, the crucial performance parameter is not the efficiency itself, but the **systematic** error on determining it

Different **independent** trigger selections allows good cross-calibration of the efficiency

Besides your “physics” triggers, foresee additional **back-up triggers**

Trigger efficiency measurement

The threshold is not exactly applied as a step function. Better it's an Error function, usually called **trigger turn-on**

► The capability of controlling the rate depends on the **resolution** on the trigger parameter

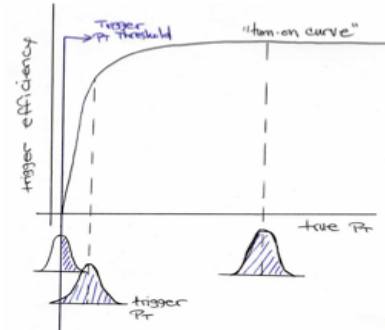

► Crucial is the study of the **step region**, in which efficiency changes very quickly and contamination from background can be important (often abundant!)

- If **quick**, better background suppression
- If **slow**, can be better extrapolated and systematic error can be reduced

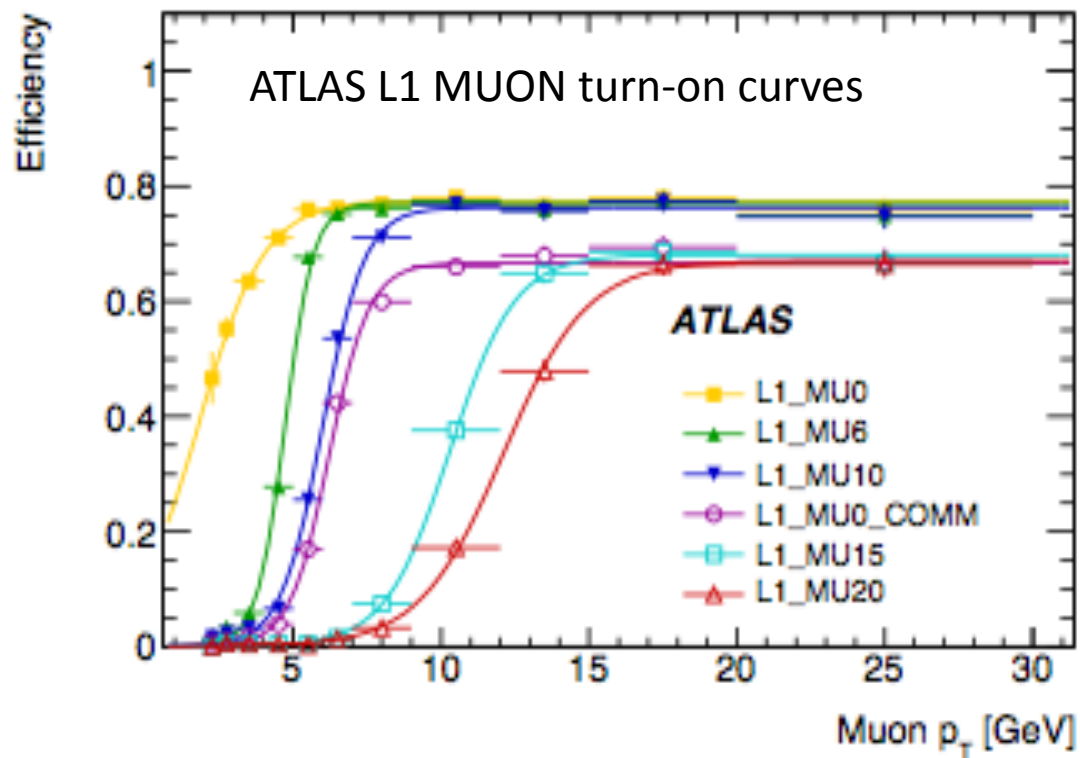

Trigger for precision measurements: BaBar

- ▶ **Goal: reduce systematic errors on the measurement of CP violating parameters**

Golden event in the BaBar Detector
e+e- collision producing a B and an anti-B

— Golden B (for CP violation)
— Tagging B

- ▶ **Babar trigger objects:**
 - ▶ **Charged tracks** in the drift chamber, with different p_T cuts:
long track (0.18GeV), short track (0.12 GeV)
 - ▶ **EM calorimeter clusters** with different E_T cuts
- ▶ Search for topology
 - ▶ **Number of objects**, optionally requiring geometrical separation cuts or matching between tracks and clusters
- ▶ **Deep studies on signal and background to minimise error on efficiency**
 - ▶ The selection of background samples must be foreseen in the trigger design

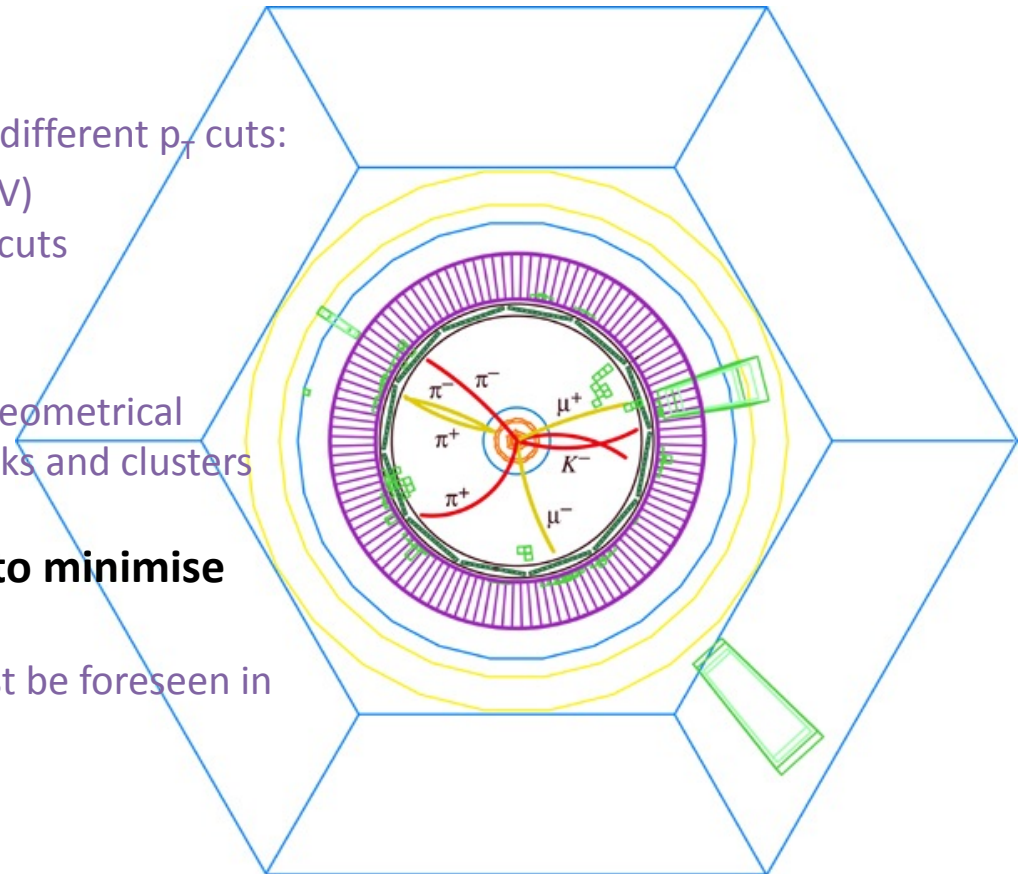

Parametrising the trigger efficiency

- ▶ The trigger behaviour, and thus the selected data sample, can change quickly due to important changes in
 - ▶ Detector
 - ▶ Trigger hardware
 - ▶ Trigger algorithms
 - ▶ Trigger definition
- ▶ The analysis must keep track of all these changes
- ▶ Multi-dimensional study of the efficiency: $\varepsilon(p_T, \eta, \phi, \text{run\#})$
 - ▶ Fit the turn-on curves for different bins of η, ϕ, p_T
 - ▶ Remind: fit the $1/p_T$ dependency since the resolution is Gaussian in $1/p_T$

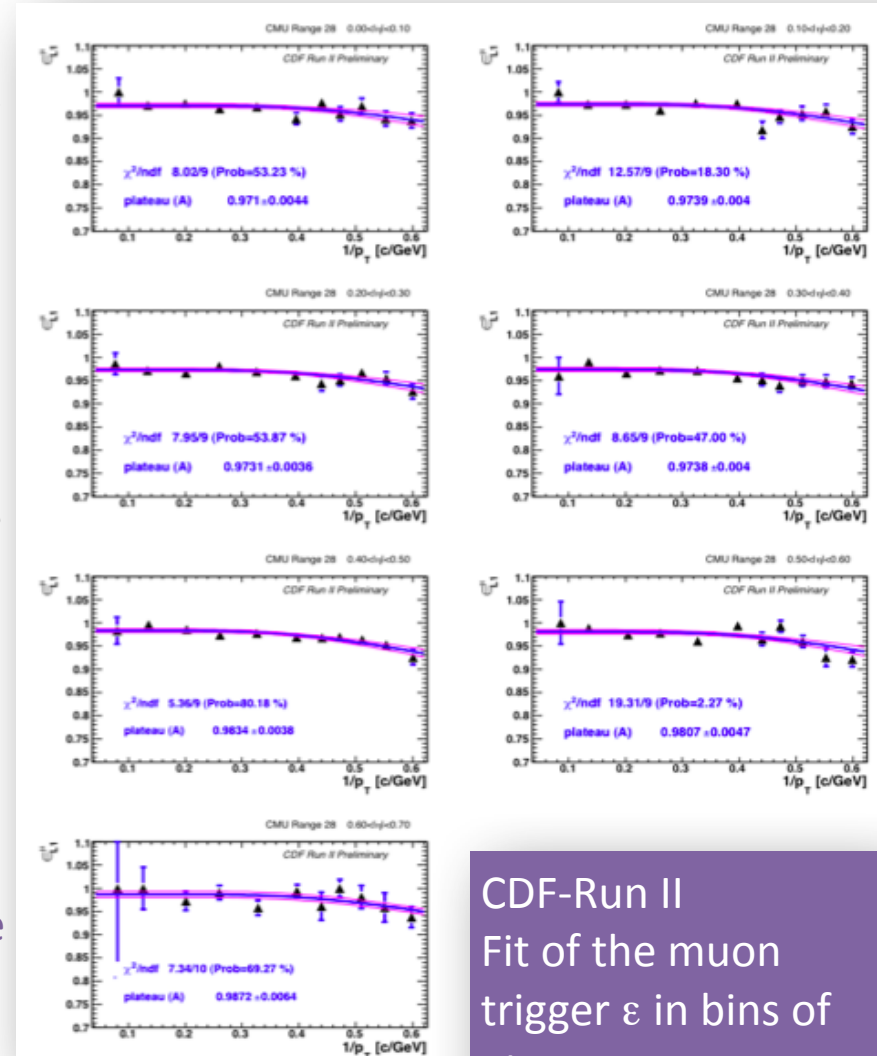

CDF-Run II
Fit of the muon
trigger ε in bins of
 η

How many trigger selections?



*Redundant and flexible
trigger menus*

- ▶ Physics triggers
 - ▶ **Discovery experiments:** multiple inclusive selections ensure wide open windows to look at
 - ▶ **Precision experiments:** multiple triggers for multiple measurements
- ▶ Calibration triggers
 - ▶ Detectors calibrations
 - ▶ Detectors and trigger efficiency measurements
 - ▶ Tagging efficiency
 - ▶ Energy scale measurements
- ▶ Background triggers
 - ▶ Instrumental and physics background
 - ▶ Better description of the background can be extrapolated from data than from Monte Carlo
 - ▶ Understand resolutions, including the under-threshold population
- ▶ Monitor triggers
 - ▶ To monitor the trigger itself (remember, lost events are lost for ever!)

Bulk of the
selected
events!

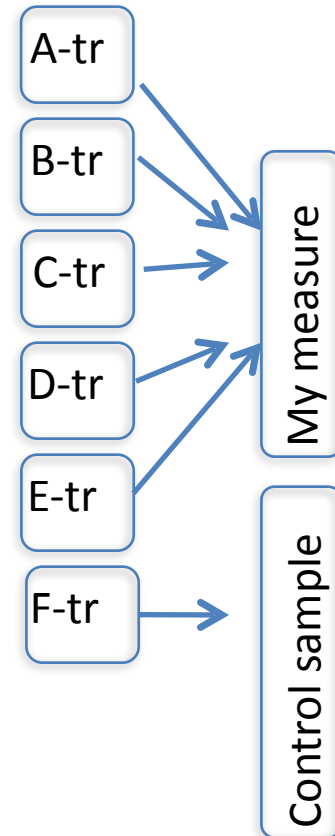

Rate allocations of the trigger signatures

- ✓ The target is the final allowed DAQ bandwidth
- ✓ The rate allocation on each trigger based on
 - ✓ Physics goals (plus calibration, monitoring samples)
 - ✓ Required efficiency and background rejection
 - ✓ Bandwidth consumed

Rates scale linearly with luminosity, but linearity is smoothly broken due to pile-up

$$R_i = L \int_{p_{T_inf}}^{p_{T_cutoff}} \frac{d\sigma_i}{dp_T} \cdot \epsilon(p_T) dp_T$$

Trigger Efficiency

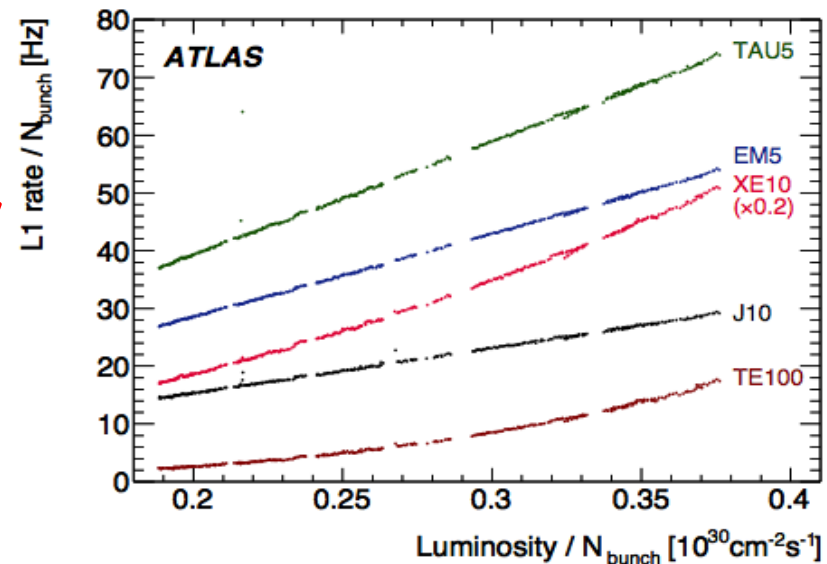

Why need to extrapolate trigger rates at given L?

- ▶ **For trigger design and commissioning:** large samples of simulated data, including large cross-section backgrounds
 - ▶ 7 million of non-diffractive events used in the ATLAS trigger design
 - ▶ Large uncertainties due to detector response and background cross-sections: apply **safety factors**, then tuned with data
- ▶ **During running (at colliders):** but only some rates can be easily extrapolated to higher L

Trigger strategy @ colliders: ATLAS menu

ATLAS

Trigger rates per signature at 10^{33}

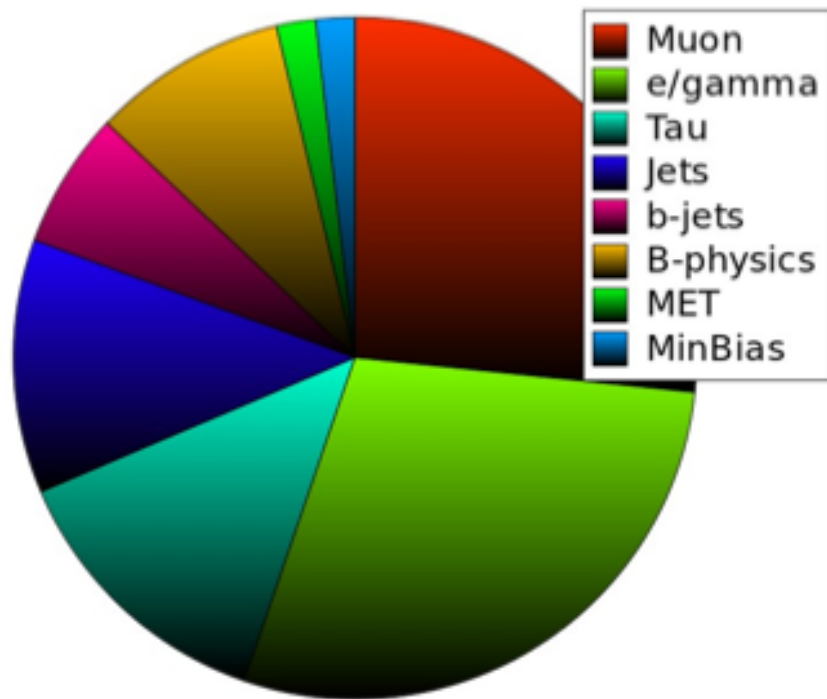

- ▶ Inclusive triggers to collect the **signal samples**
 - ▶ Single high- p_T
 - ▶ e/ μ / γ ($p_T > 20$ GeV)
 - ▶ jets ($p_T > 100$ GeV)
 - ▶ Multi-object events
 - ▶ e-e, e- μ , μ - μ , e- τ , e- γ , μ - γ , etc... to further reduce the rate
- ▶ **Back-up triggers** designed to spot problems, provide control samples (often pre-scaled)
 - ▶ Jets ($p_T > 8, 20, 50, 70$ GeV)
 - ▶ Inclusive leptons ($p_T > 4, 8$ GeV)
 - ▶ Lepton + jet

Priority List for >300 Hz

Chain		Unique rate L1 (Hz)	Unique rate L2 (Hz)	Unique rate EF (Hz)	Sorted by Problem level
EF_xe60_verytight_noMu	SUSY/Exotics	0	0	0.5	EF (pileup)
EF_j100_a4tc_EFFS_ht400	SUSY	0	0	2.5	EF
EF_4j45_a4tc_EFFS	SUSY/SM	0	0	2	EF
EF_5j30_a4tc_EFFS		0	5	3	EF
EF_j240_a10tc_EFFS	Exotics/SM	0	0	1	EF
EF_tau29_loose1_xs45_loose_noMu_3L1J10	Higgs	0	40	5	EF
EF_b10_medium_4j30_a4tc_EFFS	Top/Higgs	0	4	10	EF
EF_2mu4_BmumuX	B-physics	0	7	0.9	EF
EF_2mu4_Jpsimumu		0	6	1.7	EF
EF_mu4mu6_DiMu		0	25	6.5	EF
EF_mu4mu6_DiMu_DY20	SM	0	10	5?	EF
EF_2MUL1_l2j30_HV_allMS	Exotics	0	?	?	EF
EF_mu20i_medium	5x10 ³³ prep.	0	15	3	EF
EF_mu18_MG_medium		0	0	60	EF
EF_mu18_medium	Many	0	0	60	EF
EF_e60_loose	(Exotics)	0	5	7	EF,client
EF_mu15/18/22_njX?	SUSY/??	100	10	?	EF,non-validated
EF_g22_hiptrt?	Exotics	0	?	< 1?	non-validated
EF_e15_medium_xe40_noMu	SUSY/Exotics	310	70?	1.3	L2 (pileup)
EF_j55_a4tc_EFFS_xe55_medium_noMu_dphi2j30xe10		70	210	1.5	L2
EF_e10_medium_mu6_topo_medium	Higgs	1200	9	1	L1
EF_tau20_medium_e15_medium	Higgs	3700	10	1	L1
EF_xe60_tight_noMu	SUSY	680?	150?	1	L1,L2 (pileup),EF
EF_e10_medium_mu6	Higgs/SUSY	1200	75	10	L1, EF
EF_l2j30_Trackless_HV_L1MU6	Exotics	1500?	0.5	0.5	L1
Total extra rate		6500	600	100	Peak at 3 × 10 ³³



Build up a trigger system

Ensure good efficiency with...



Robustness! Win against the unexpected!

- ▶ **Flexibility: to cope changes in conditions and background**
 - ▶ Programmable thresholds, high granularity to maintain uniform performance, able to follow changes of luminosity, beam-size and vertex position, able to reach physics results also after 10 years of data taking
- ▶ **Redundancy: to make trigger rates independent from the detector and the collider performance**
 - ▶ Different backgrounds can change the event shape and dimension, so the result of your trigger selection
- ▶ **Selectivity**
 - ▶ Good granularity and good resolution of the parameters to ensure rejection of the unwanted background

Trigger and data acquisition trends

$$R_{DAQ} = R_T^{max} \times S_E$$

As the data volumes and rates increase, new architectures need to be developed

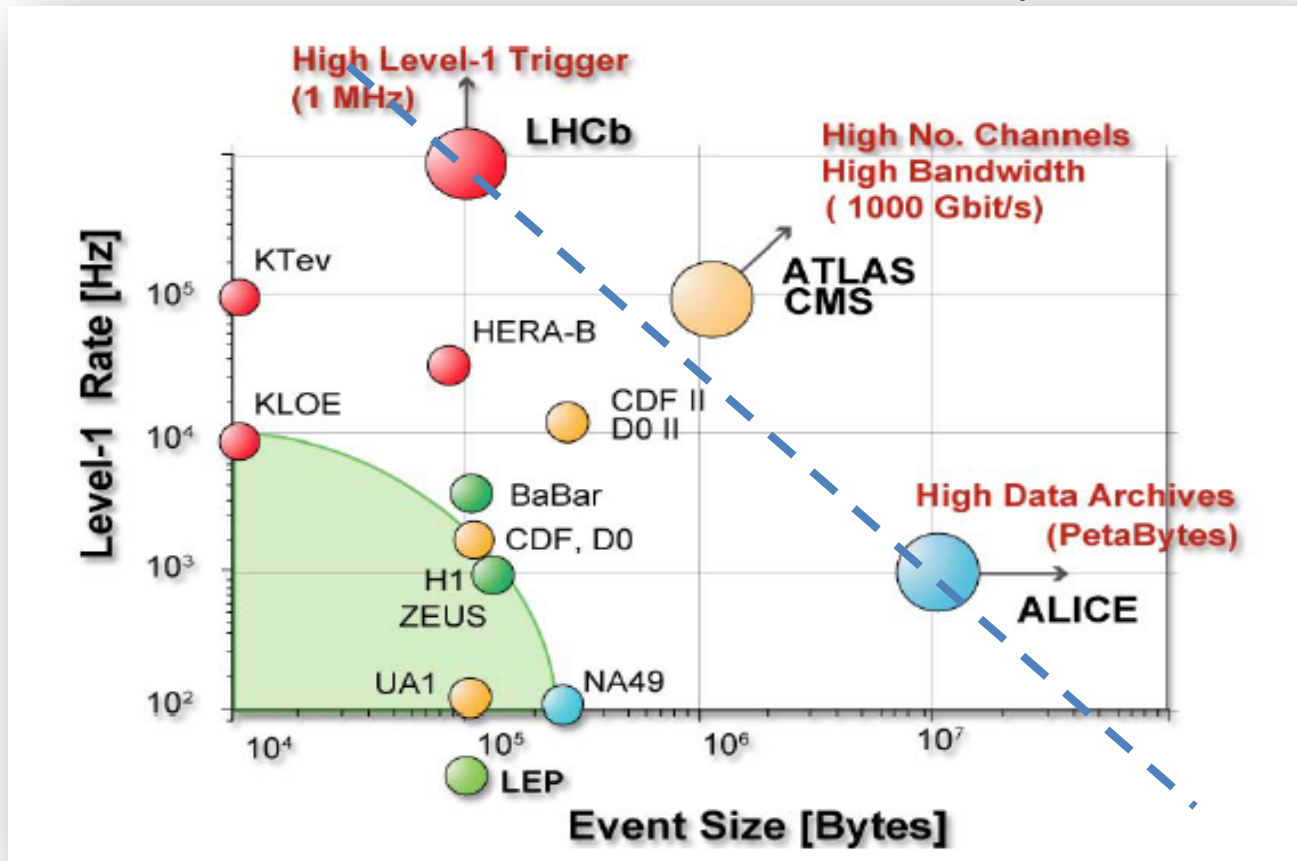

The simplest trigger system

- ▶ **Source:** signals from the Front-End of the detectors
 - ▶ Binary trackers (pixels, strips)
 - ▶ Analog signals from trackers, time of light detectors, calorimeters,....

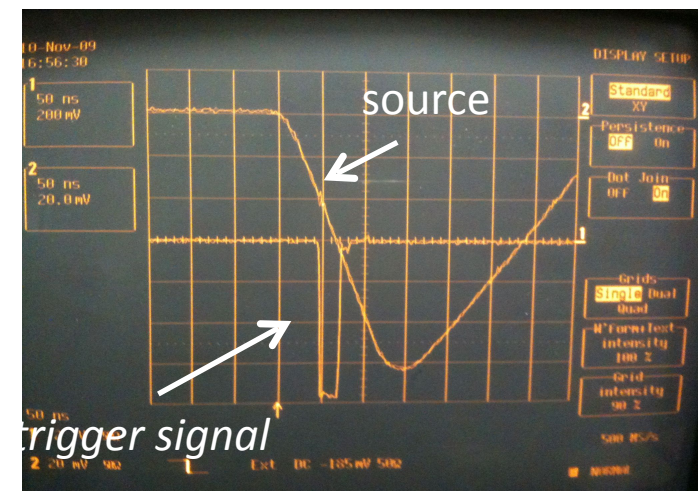
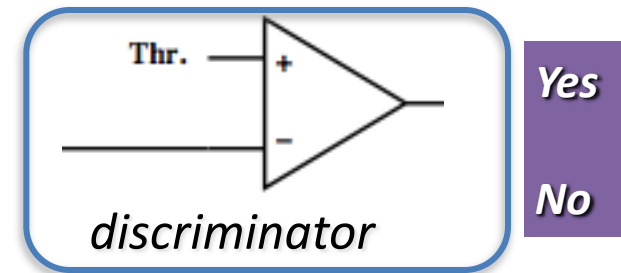
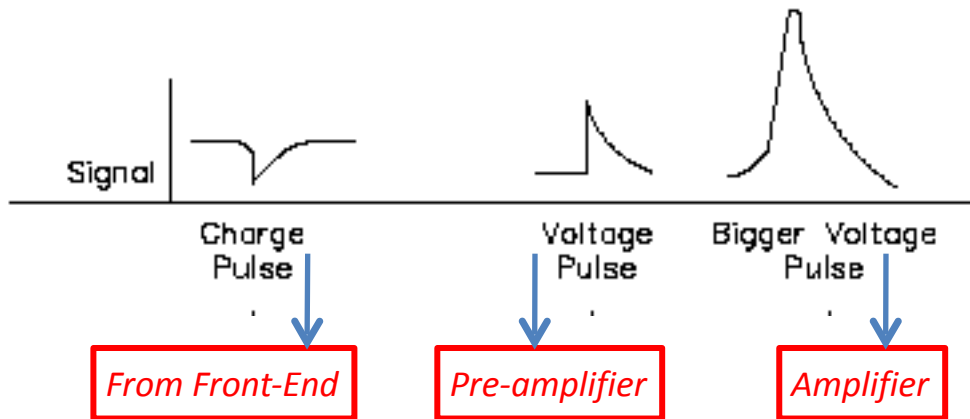

- ▶ The simplest trigger is: **apply a threshold**
 - ▶ Look at the signal
 - ▶ Apply a threshold as low as possible, since signals in HEP detectors have large amplitude variation
 - ▶ Compromise between hit efficiency and noise rate

Chose your trigger detector

▶ Use signals from either existing detectors or dedicated “trigger detectors”

- ▶ Organic scintillators
- ▶ Electromagnetic calorimeters
- ▶ Proportional chambers (short drift)
- ▶ Cathode readout detectors (RPC,TGC,CSC)

▶ With these requirements

▶ **Fast signal:** good time resolution and low jittering

- ▶ Signals from slower detectors are shaped and processed to find the unique peak (peak-finder algorithms)

▶ **High efficiency**

▶ **(often) High rate capability**

▶ **Need optimal FE/trigger electronics to process the signal (common design)**

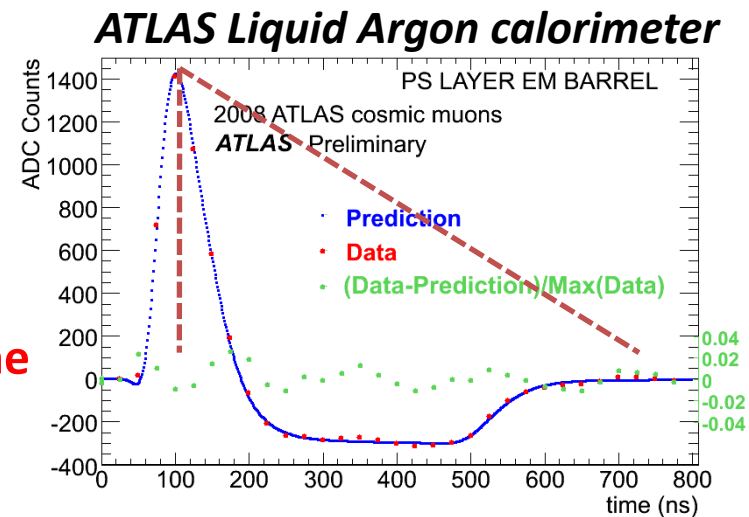
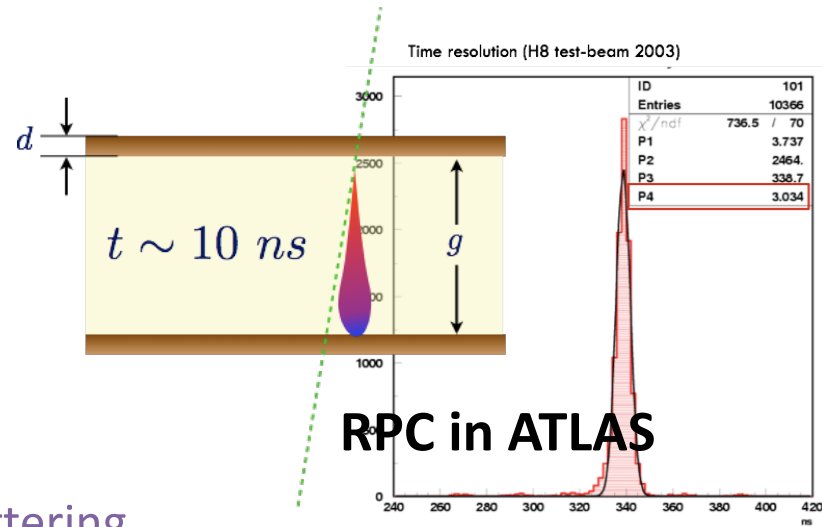

Trigger signatures

- ▶ Can collect **many** parameters for discrimination of given topology
 - ▶ Not only the amplitude of a signal
 - ▶ More complex quantities by software calculations (MultiVariate Analysis)
- ▶ At first, use intuitive criteria: **be fast and reliable!**
 - ▶ Use clear/simple signatures
 - ▶ i.e.: apply thresholds on: muon momenta, energy deposits in the calorimeters, good quality tracks in the tracker detectors....

- ▶ Eventually combine more signals together following a certain trigger logic (AND/OR), giving **redundancy**

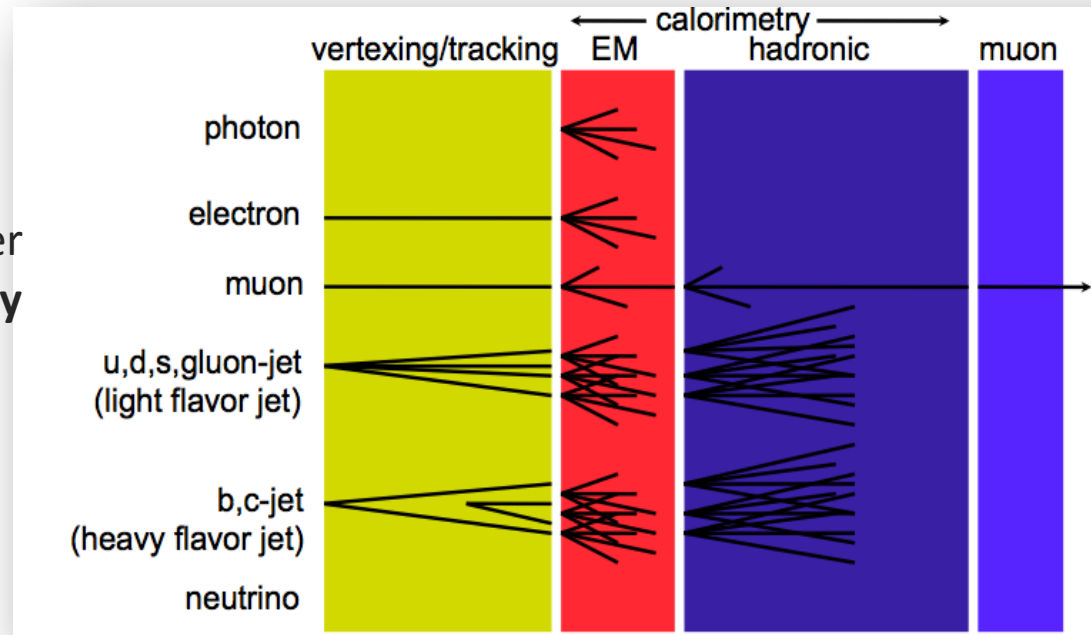

Hardware trigger logic implementation

- ▶ Analog systems: amplifiers, filters, comparators,
- ▶ Digital systems:
 - ▶ Combinatorial: sum, decoders, multiplexers,....
 - ▶ Sequential: flip-flop, registers, counters,....
- ▶ Converters: ADC, TDC,

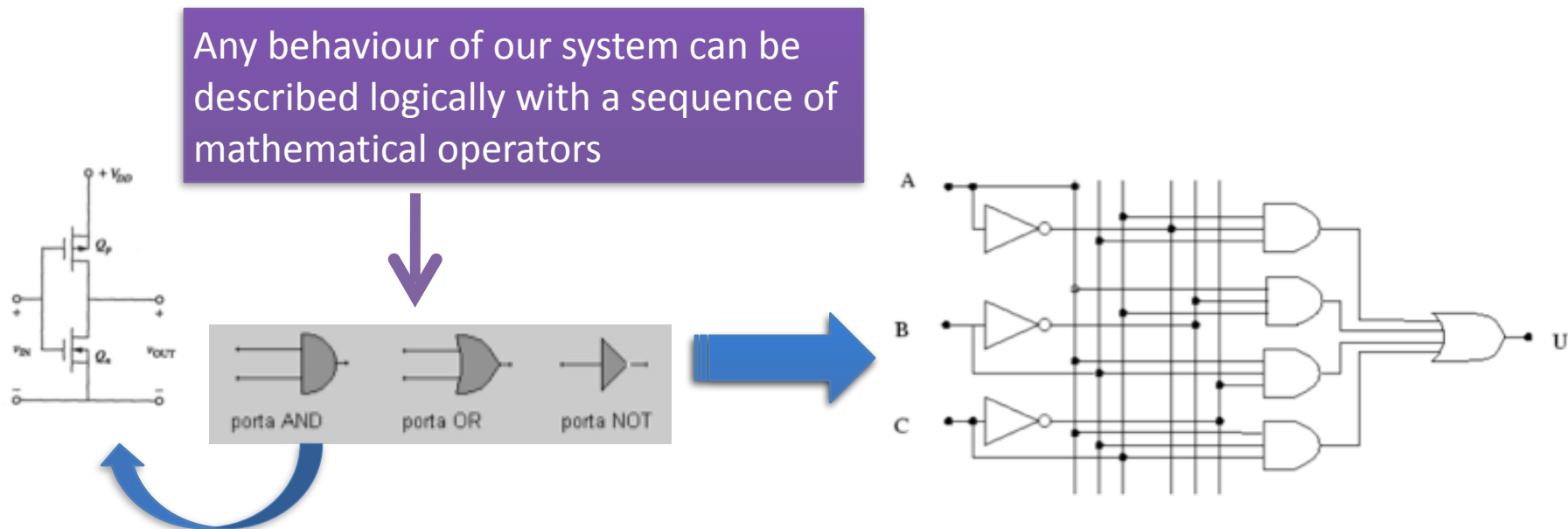

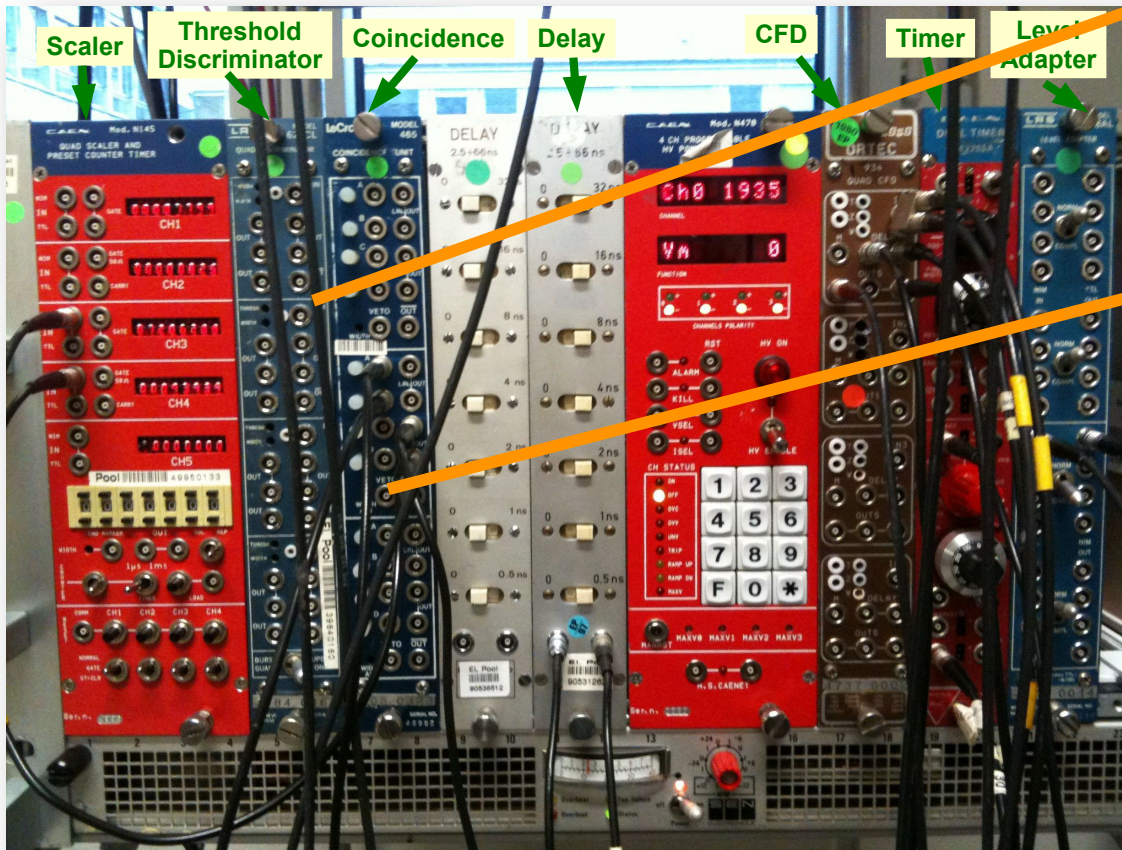

Scaler

Threshold Discriminator

Coincidence

Delay

CFD

Timer

Level Adapter



Threshold Discriminator



Coincidence Unit

A simple trigger system

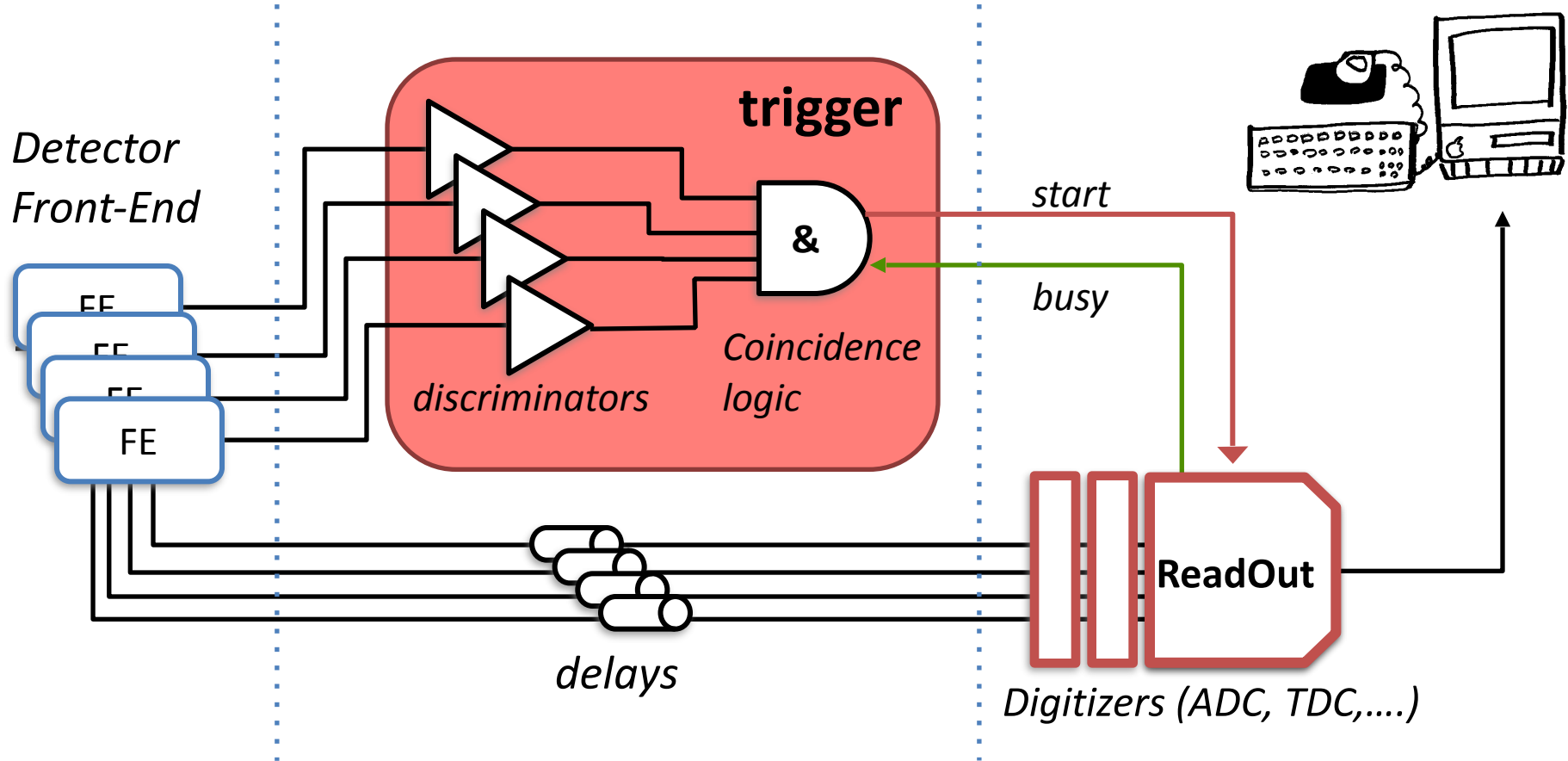

- ▶ Due to **fluctuations**, the incoming rate can be higher than processing one
- ▶ Valid interactions can be rejected due to system **busy**

Dead-time

- ▶ The most important parameter in designing high speed **T/DAQ** systems
 - ▶ The fraction of the acquisition time in which no events can be recorded. It can be typically of the order of **few %**
 - ▶ Occurs when a given step in the processing takes a **finite amount of time**
 - ▶ Readout dead-time
 - ▶ Trigger dead-time
 - ▶ Operational dead-time
- Fluctuations produce dead-time!**

Affects efficiency!

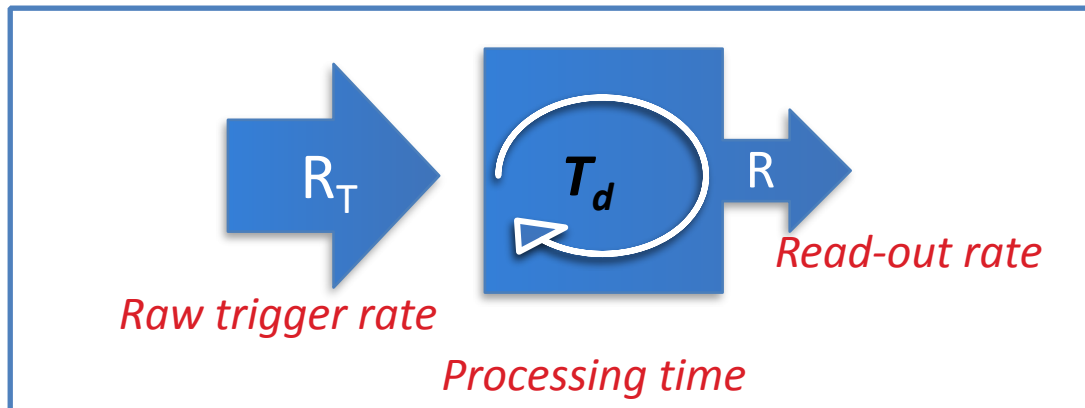

System Timing Diagram

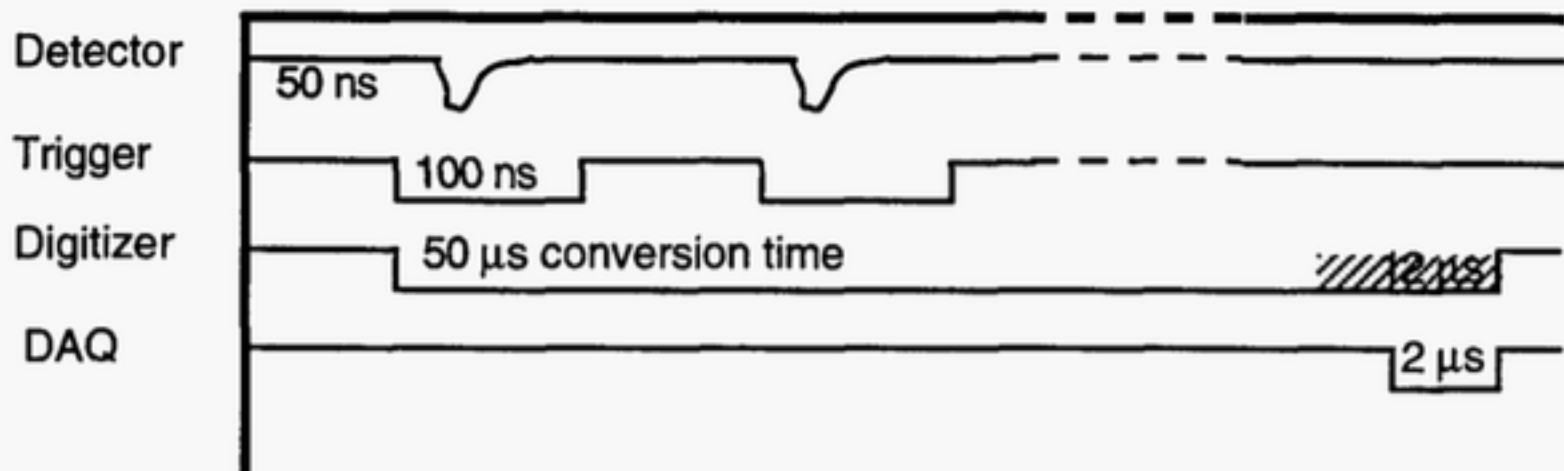

Maximise recording rate

R_T = Trigger rate (average)

R = Readout rate

T_d = processing time of one event

fraction of lost events = $R \times T_d$

number of events read: $R = (1 - R \times T_d) \times R_T$

$$\frac{R}{R_T} = \frac{1}{1 + R_T T_d}$$

Fraction of surviving events!

- ▶ We always lose events if $R_T > 1/T_d$
- ▶ If exactly $R_T = 1/T_d$ -> dead-time is 50%

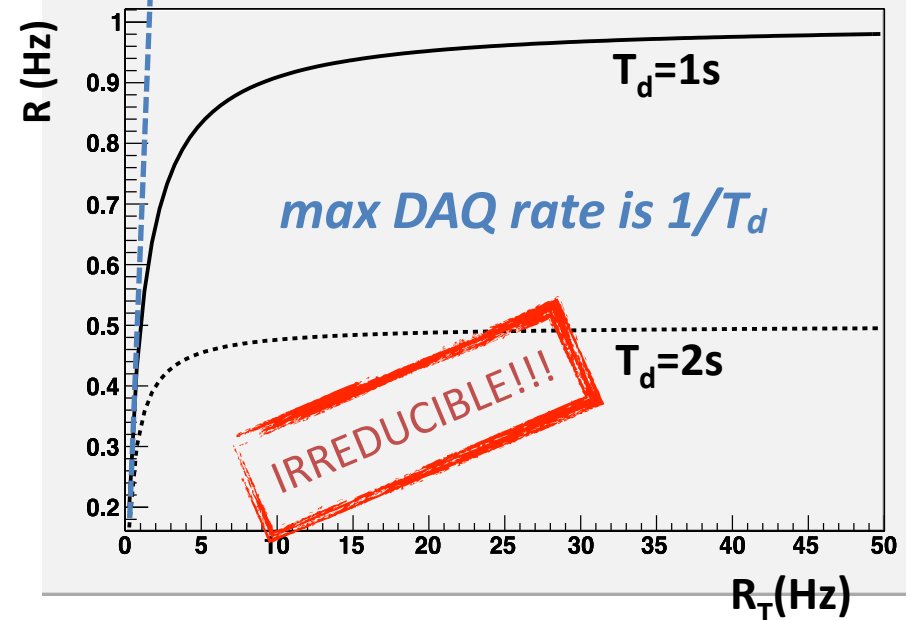
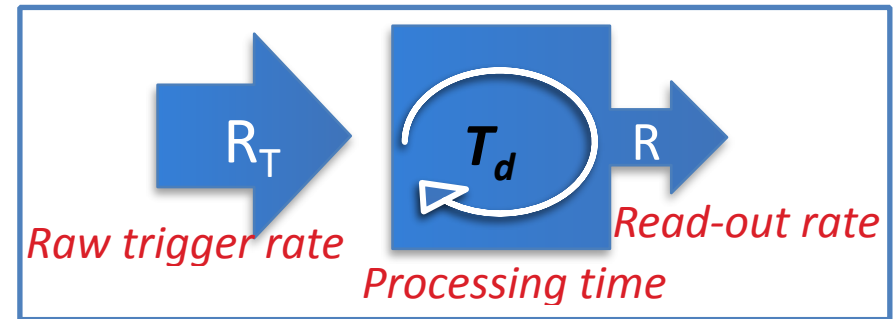

The trick is to make both R_T and T_d as small as possible ($R \sim R_T$)

FAST TRIGGER!
LOW INPUT RATE!

A simple trigger system

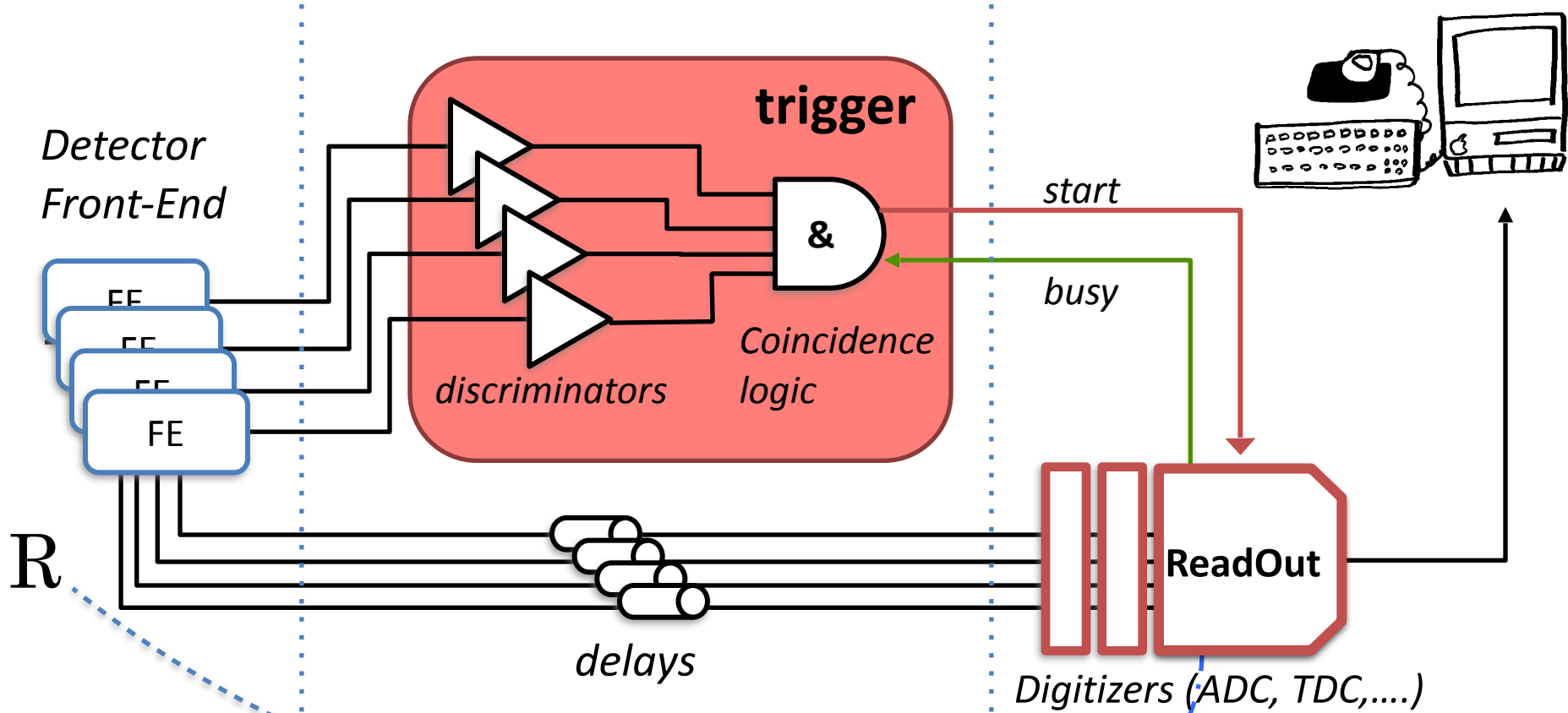

$$D_t \Rightarrow R \cdot T_{RO}$$

Fraction of lost events due to finite readout

To minimise dead-time....

► 1: Parallelism

- Independent readout and trigger processing paths, one for each sensor element
- Digitisation and DAQ processed in parallel (as many as affordable!)

Segment as much as you can!

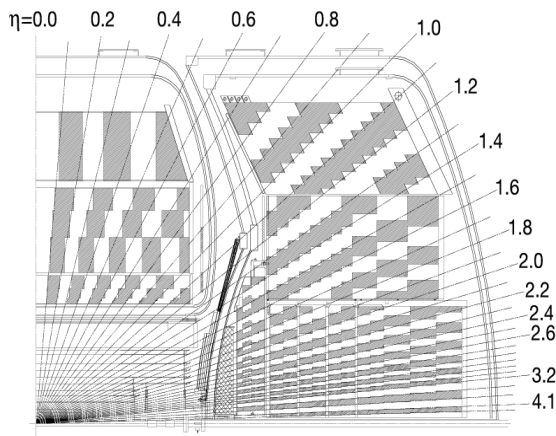

DZero calorimeters showing the transverse and longitudinal segmentation pattern

► 2: Pipeline processing with intermediate buffers, to absorb fluctuations

- Organise the process in different steps
- Use local **buffers** between steps with different timing

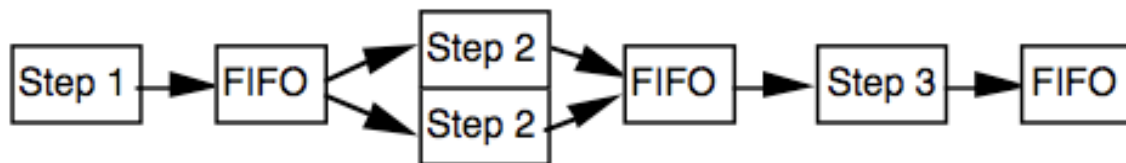

$$\frac{R}{R_T} = \frac{1}{1 + R_T T_d}$$

Try to absorb in capable buffers

Minimising readout dead-time...

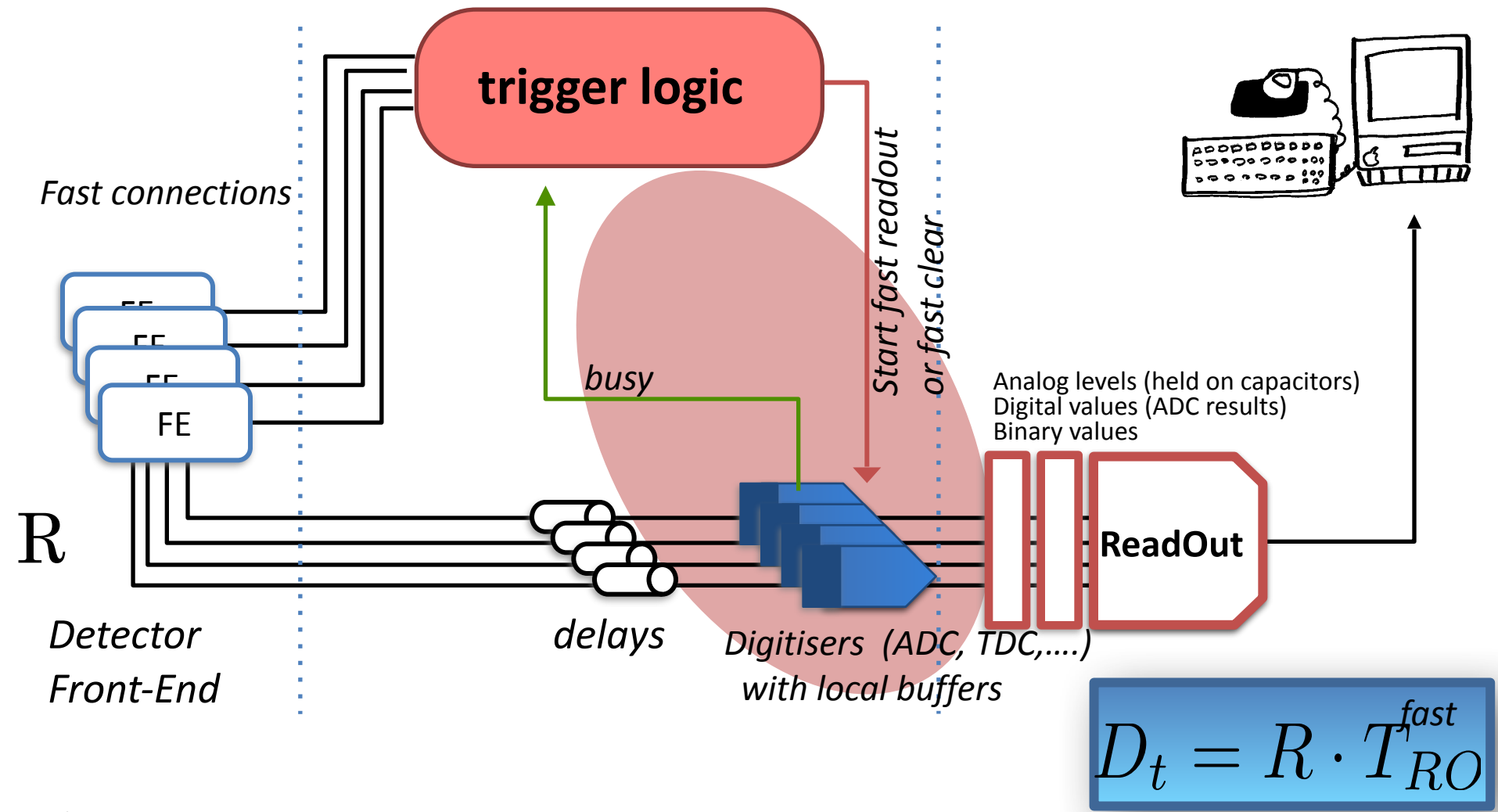

- ▶ **Parallelism:** Use multiple digitisers
- ▶ **Pipelining:** Different stages of readout: fast local readout + global event readout (slow)

Trigger latency

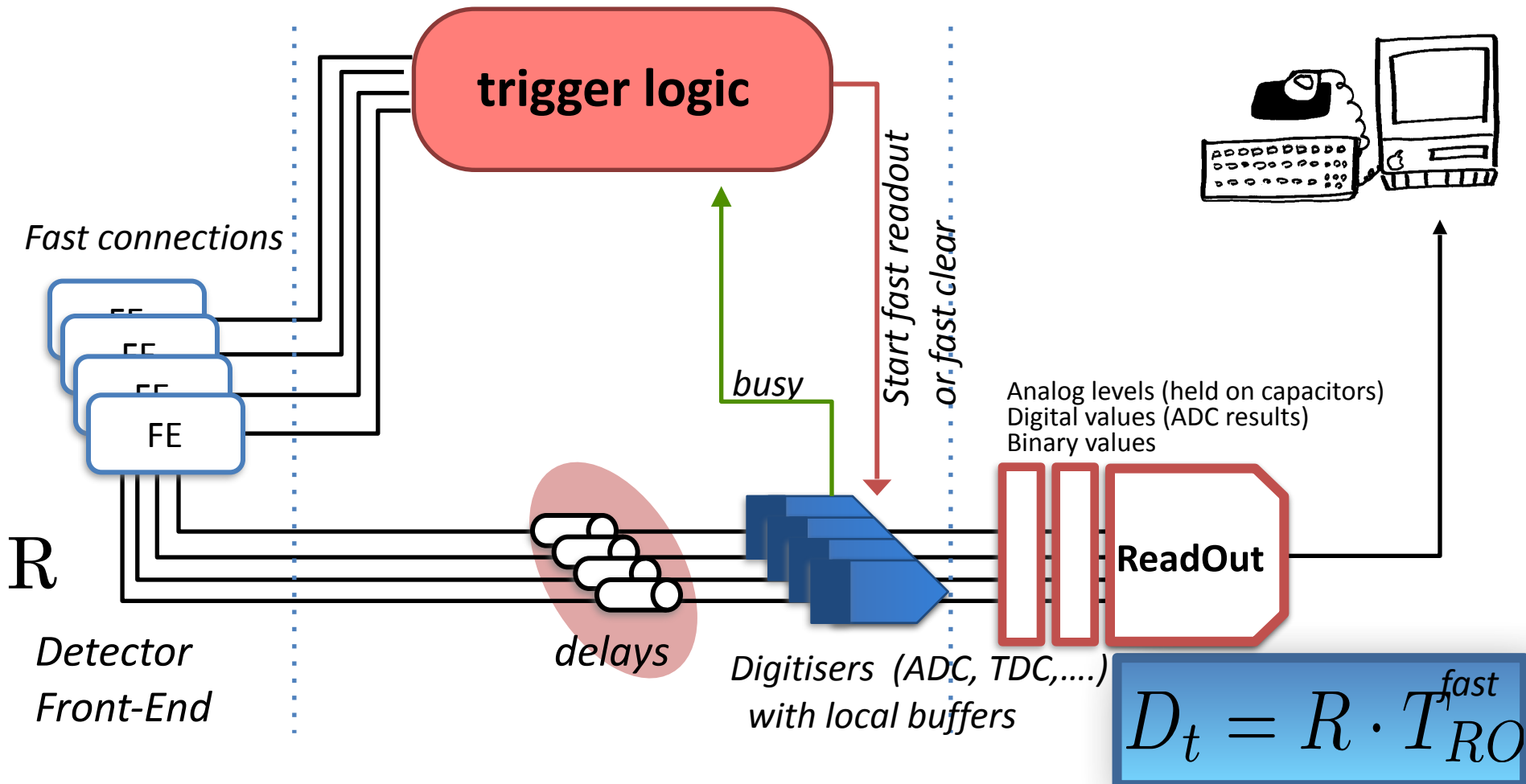

- ▶ Time to form the trigger decision and distribute to the digitisers
- ▶ Signals are delayed until the trigger decision is available at the digitisers
 - ▶ But more complex is the selection, longer is the latency

Add a pre-trigger

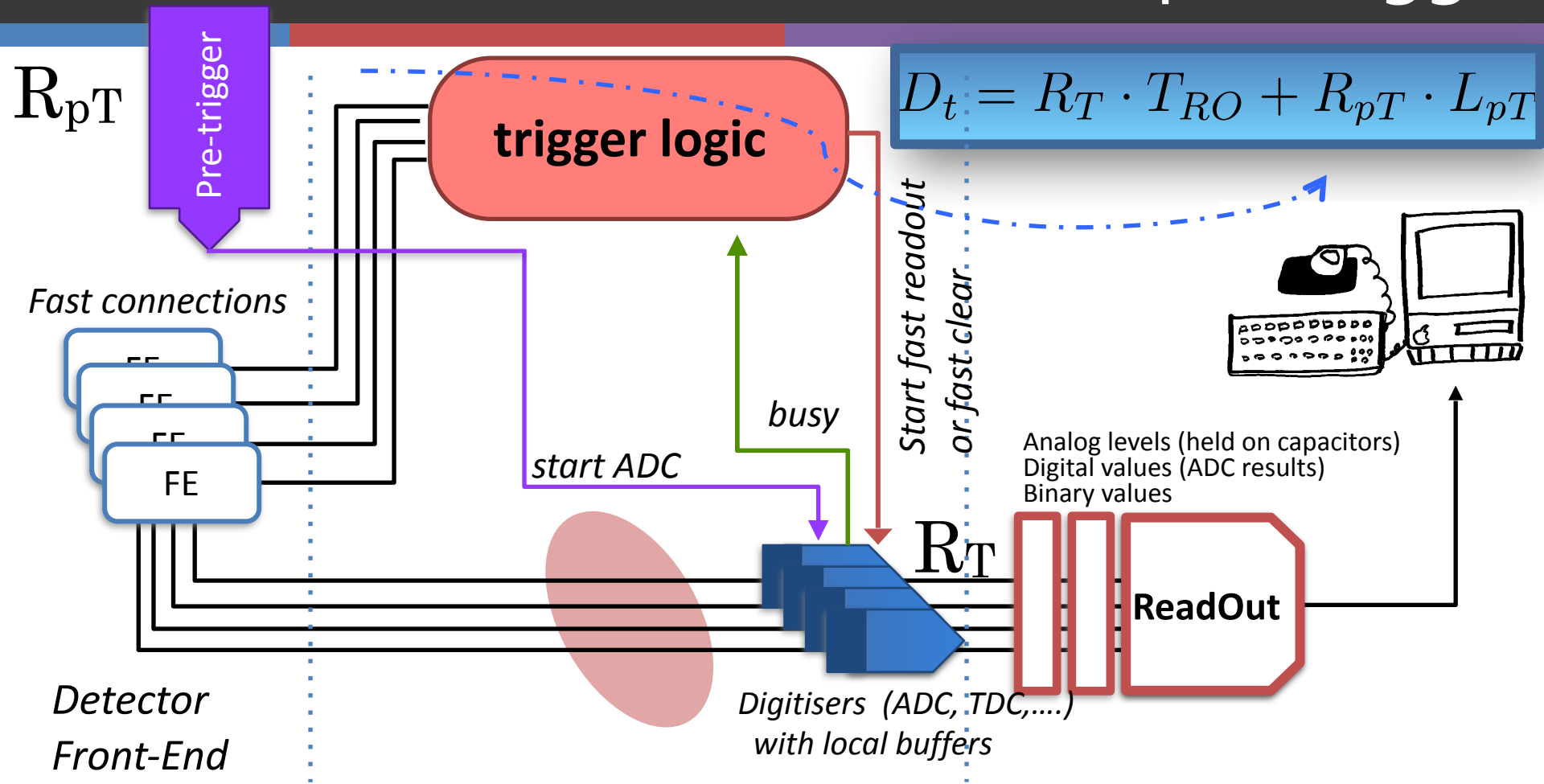

- ▶ Add a **very fast** first stage of the trigger, signalling the presence of minimal activity in the detector
 - ▶ **START** the digitisers, when signals arrive
 - ▶ The main trigger decision comes later (after the digitisation) -> can be more complex

Coupling rates and latencies

- ▶ Extend the idea... **more levels of trigger**, each one reducing the rate, even with longer latency
- ▶ Dead-time is the sum of the trigger dead-time, summed over the trigger levels, and the readout dead-time

$$\left(\sum_{i=2}^N R_{i-1} \times L_i \right) + R_N \times T_{LRO}$$

$i=1$ is the pre-trigger

R_i = Rate after the i -th level

L_i = Latency for the i -th level

T_{LRO} = Local readout time

Readout dead-time is minimum if its input rate R_N is low!

Try to minimise each factor!

Buffering and filtering

- ▶ **At each step**, data volume is reduced, more refined filtering to the next step
 - ▶ The **input** rate defines the filter **processing time** and its **buffer size**
 - ▶ The **output** rate limits the maximum latency allowed in the **next step**
 - ▶ Filter **power** is limited by the capacity of the next step

As long as the buffers do not fill up (overflow), no additional dead-time is introduced!

→ *BUSY signal is still needed*

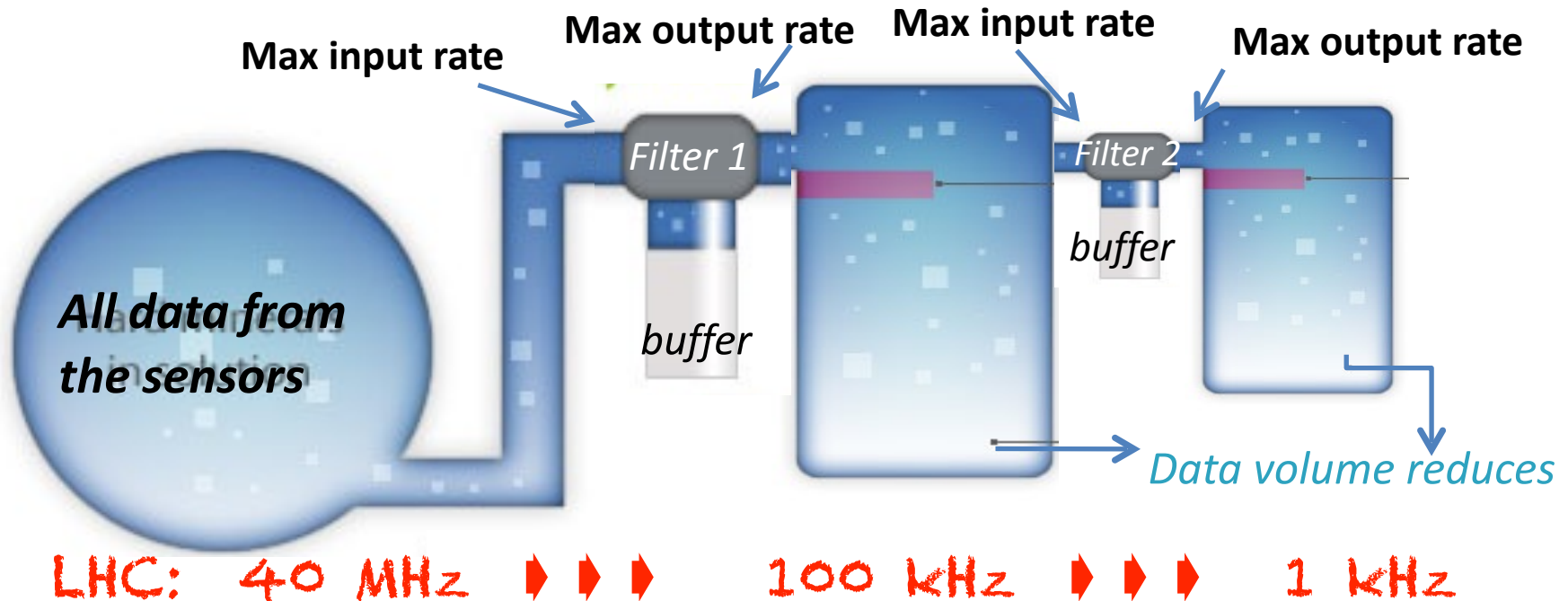

Rates and latencies are strongly connected

- ▶ If the rate after filtering is **higher** than the capacity of the next step
 - ▶ Add filters (tighten the selection)
 - ▶ Add better filters (more complex selections)
 - ▶ Discard randomly (pre-scales)
- ▶ Latest filter can have longer latency (more selective)

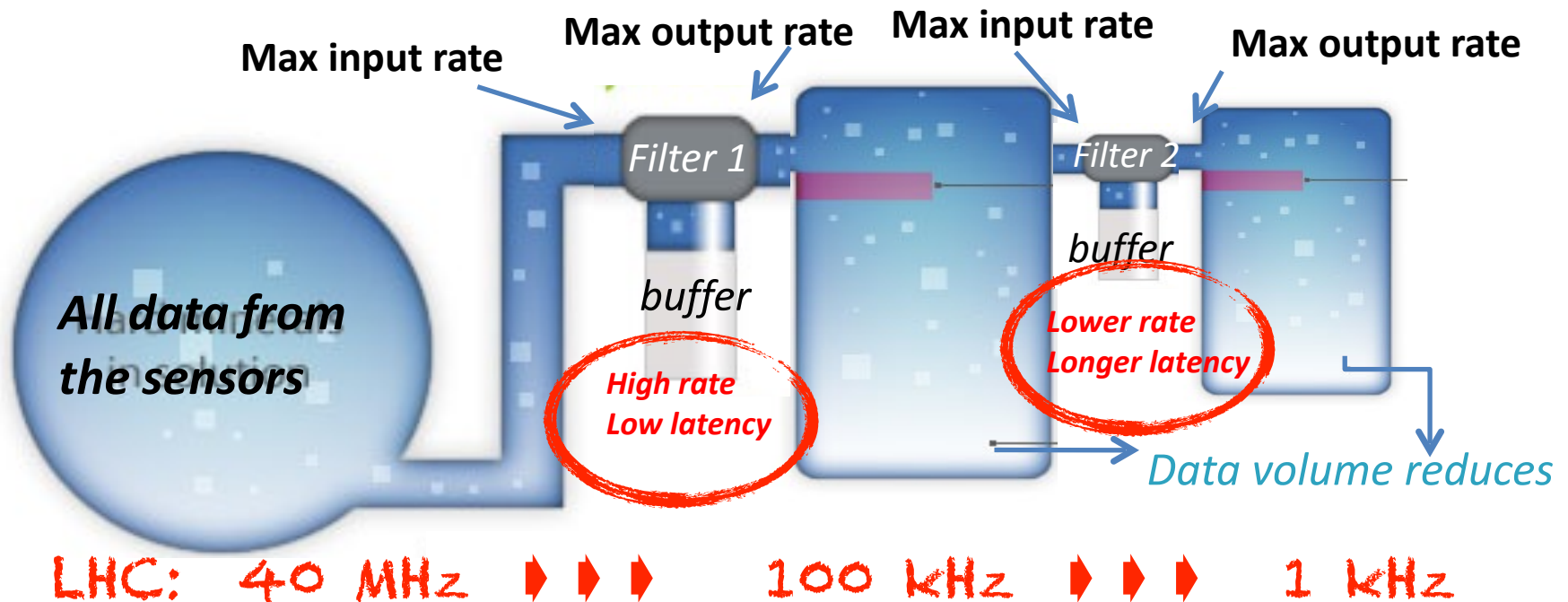

Multi-level triggers

- ▶ Adopted in large experiments with large data volume
- ▶ Successively more complex decisions are made on successively lower data rates
 - ▶ First level with short latency, working at higher rates
 - ▶ Higher levels apply further rejection, with longer latency (more complex algorithms)



LHC experiments @ Run1

Exp.	N.of Levels
ATLAS	3
CMS	2
LHCb	3
ALICE	4

Lower event rate
Bigger event fragment size
More granularity information
More complexity
Longer latency
Bigger buffers

Efficiency for the desired physics must be kept high at all levels, since rejected events are lost for ever

Use of multi-level trigger

Example for LHC

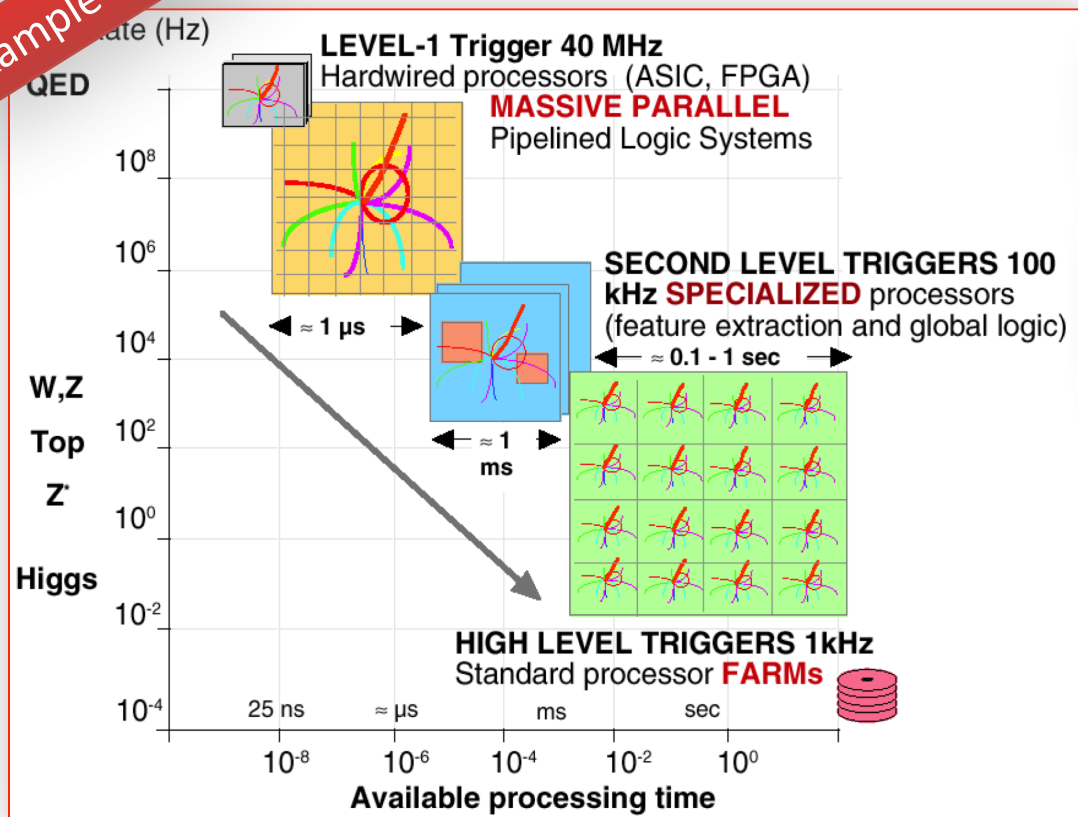

Architectural view

L1: Inclusive trigger

L2: Confirm L1, inclusive and semi-incl., simple topology, vertex rec.

L3: Confirm L2, more refined topology selection, near offline

Logical view

Schema of a multi-level trigger

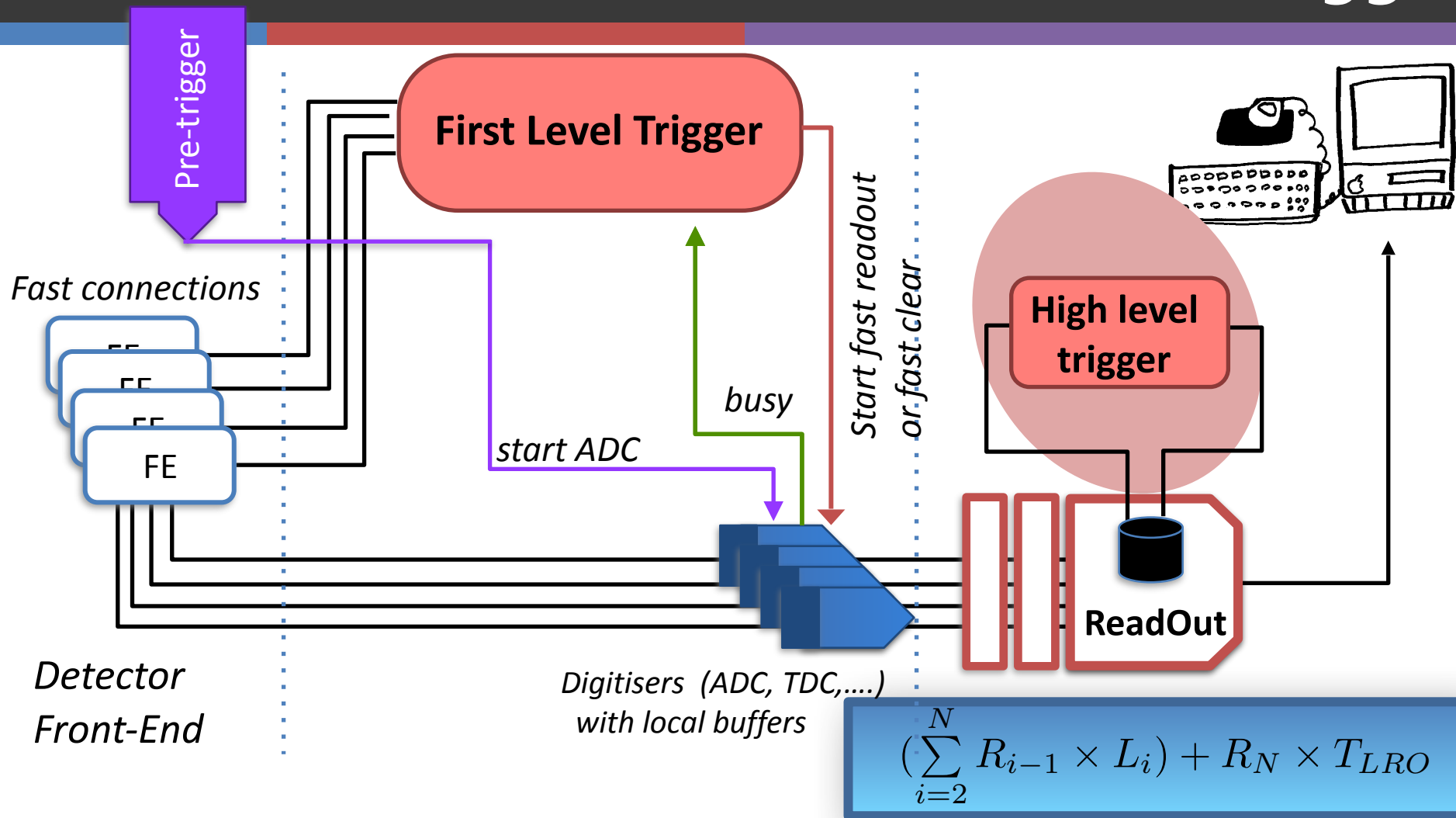

- ▶ Different levels of trigger, accessing different buffers
- ▶ The pre-trigger starts the digitisation

Schema of a multi-level trigger @ colliders

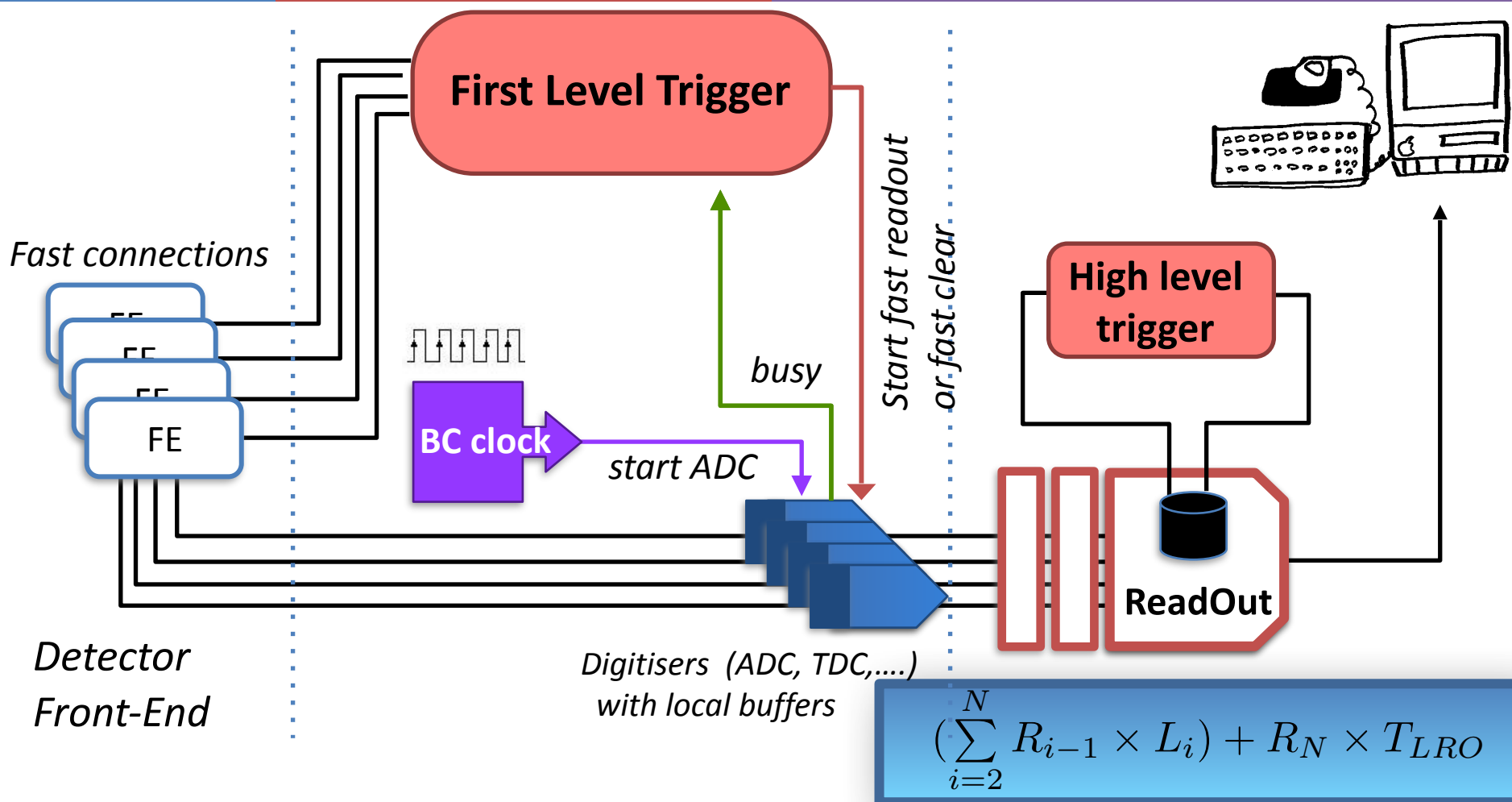

- ▶ The BC clock can be used as a pre-trigger
 - ▶ First-level trigger is **synchronous** to the collision clock: can use the time between two collisions to make its decision, without dead-time

Simple signatures: Auger observatory

- ▶ Detect air showers generated by cosmic rays above 10^{17} eV
 - ▶ Expected rate $< 1/\text{km}^2/\text{century}$. Two large area detectors
- ▶ On each detector, a 3-level trigger operates at a wide range of primary energies, for both vertical and very inclined showers

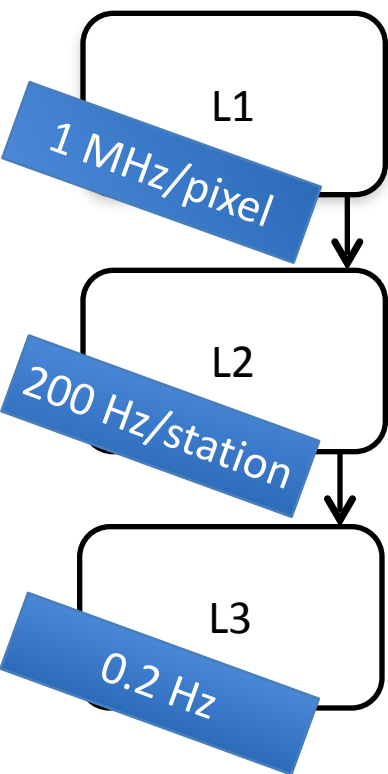

L1: (local) decides the pixel status (on/off)

- ADC counts $>$ threshold
- ADC with 100 ns (time resolution)
- ADC values stored for 100 μs in buffers
- Synchronised with a signal from a GPS clock

L2: (local) identifies track segments

- Geometrical criteria with recognition algorithms on programmable patterns

L3: (central) makes spatial and temporal correlation between L2 triggers

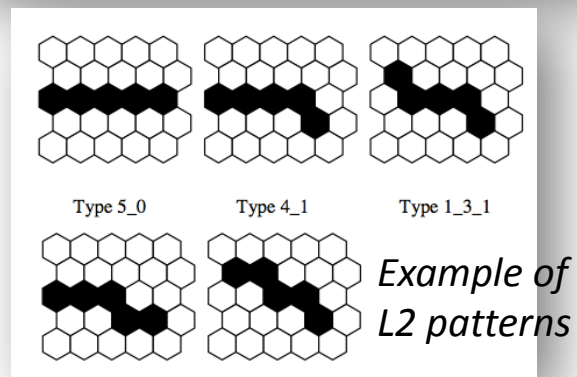
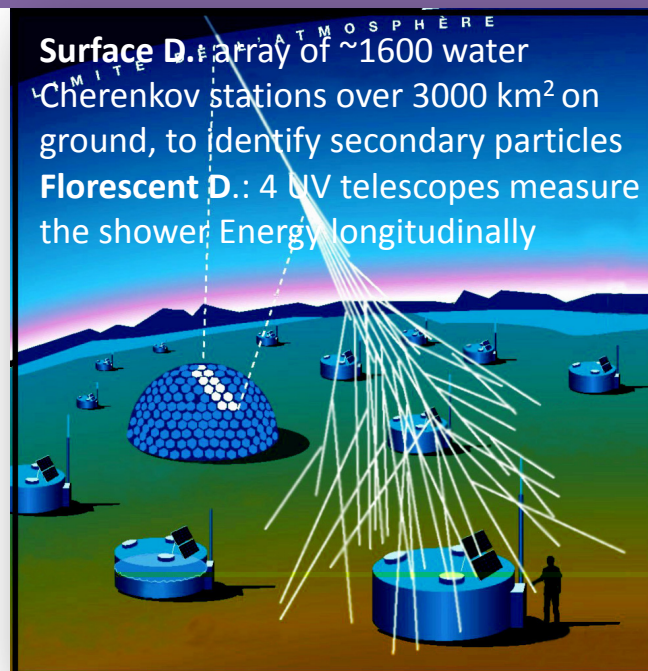

One event $\sim 1\text{MB}$ \rightarrow 0.2 MB/s bandwidth for the DAQ system

Multi objects trigger: CDF

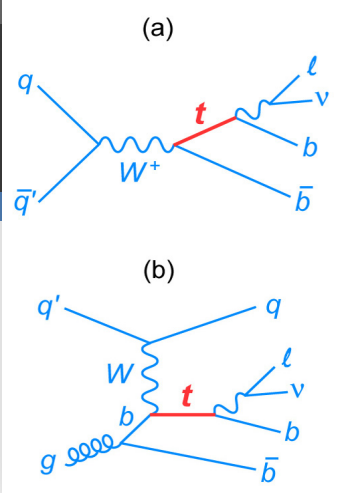

$t \rightarrow Wb \sim 100\%$

missing Energy

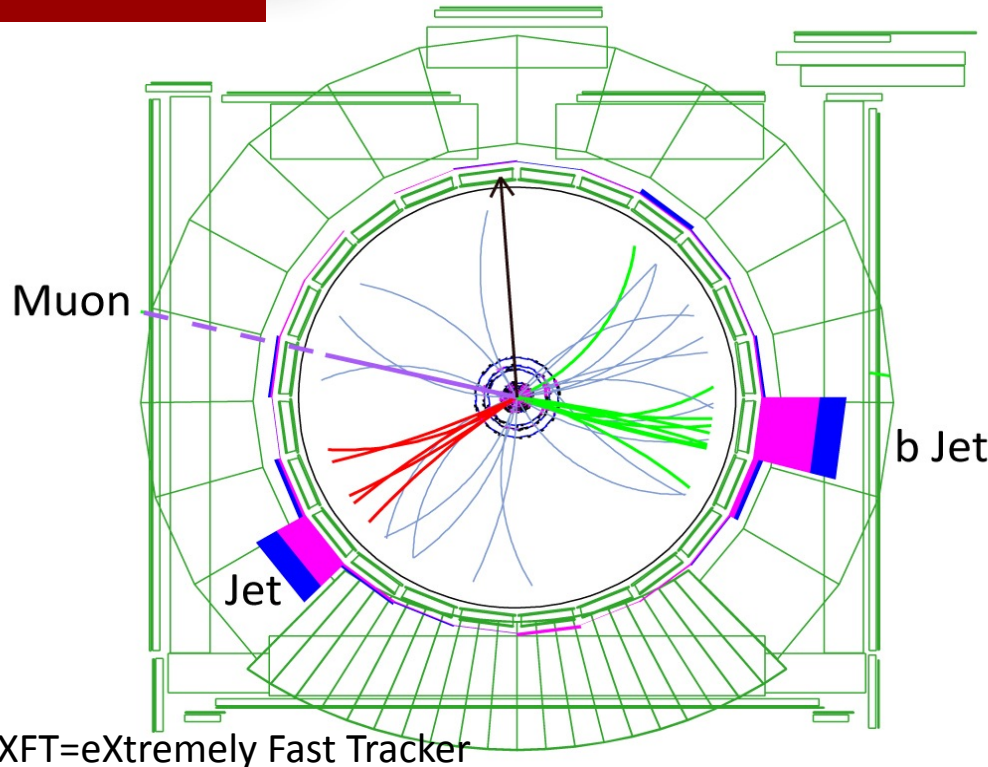

CDF single top event

- ▶ Signal characterization:
 - ▶ 1 high p_T lepton, in general isolated
 - ▶ Large MET from high energy neutrino
 - ▶ 2 jets, 1 of which is a b-jets
- ▶ Trigger objects at L1
 - ▶ Central tracking (XFT $p_T > 1.5\text{GeV}$)
 - ▶ Calorimeter
 - ▶ Electron (Cal + XFT)
 - ▶ Photon (Cal)
 - ▶ Jet (Cal EM+HAD)
 - ▶ Missing E_T , $\text{Sum}E_T$
 - ▶ Muon (Muon + XFT)
- ▶ Trigger objects at L2:
 - ▶ L1 information
 - ▶ SVT (displaced track, impact parameter)
 - ▶ Jet cluster
 - ▶ Isolated cluster
 - ▶ Calorimeter ShowerMax (CES)

Multi objects trigger: CDF

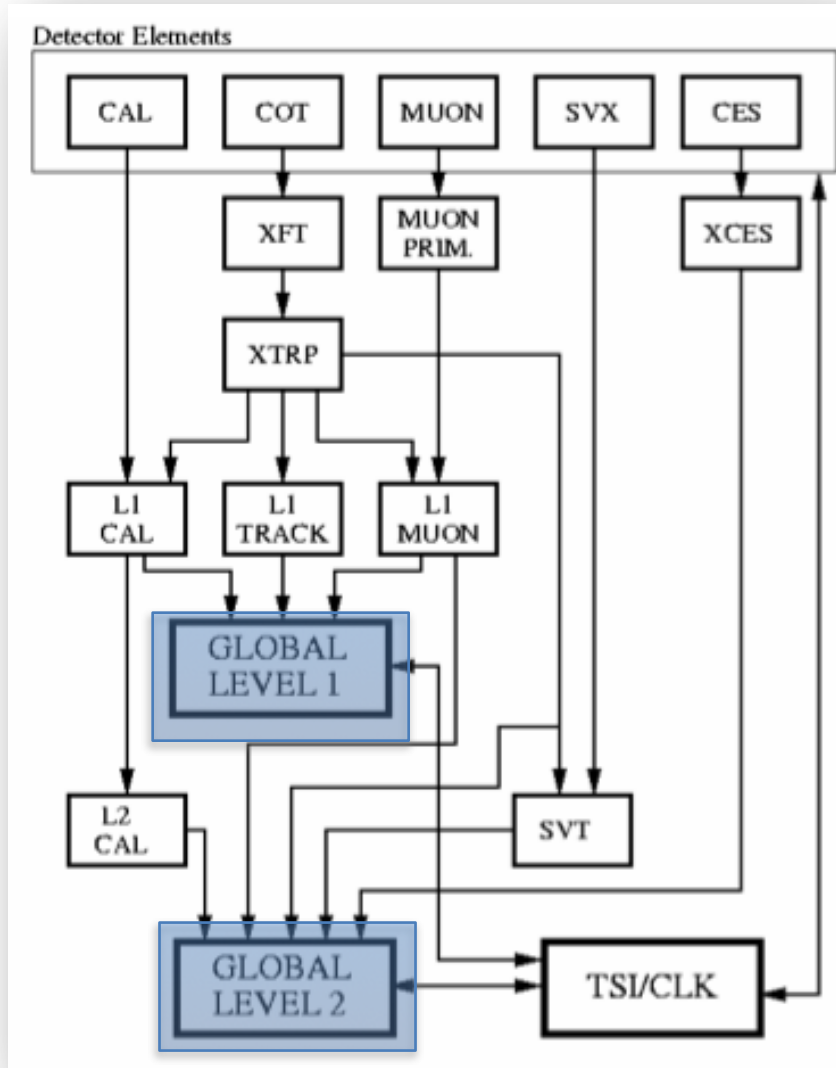

CDF single top event

- ▶ Signal characterization:
 - ▶ 1 high p_T lepton, in general isolated
 - ▶ Large MET from high energy neutrino
 - ▶ 2 jets, 1 of which is a b-jets
- ▶ Trigger objects at L1
 - ▶ Central tracking (XFT $p_T > 1.5\text{GeV}$)
 - ▶ Calorimeter
 - ▶ Electron (Cal + XFT)
 - ▶ Photon (Cal)
 - ▶ Jet (Cal EM+HAD)
 - ▶ Missing E_T , $\text{Sum}E_T$
 - ▶ Muon (Muon + XFT)
- ▶ Trigger objects at L2:
 - ▶ L1 information
 - ▶ SVT (displaced track, impact parameter)
 - ▶ Jet cluster
 - ▶ Isolated cluster
 - ▶ Calorimeter ShowerMax (CES)

Level-1: reduce the latency

- Pipelined trigger
- Fast processors
- Fast data movement



Synch level-1 trigger @ colliders

$$R = \mu \cdot f_{BC} = \sigma_{in} \cdot L$$

bunch-crossing distance

LEP: 22 μ s



TeVatron: 396 ns



HERA: 96 ns

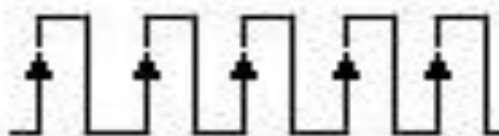

LHC: 25 ns

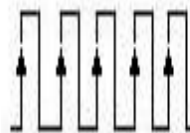

LEP
output rate = 7 Hz
trigger latency = 38 μ s
readout time = 2.5 ms
dead time 2%

- ▶ @LEP, BC interval 22 μ s: complicated trigger processing was allowed
- ▶ In modern colliders: required high luminosity is driven by high rate
 - ▶ It's not possible to make a trigger decision within this short time!

Level-1 pipeline trigger

- ▶ With a synchronous system and large buffer pipelines we can allow long **fixed trigger latency (order of μs)**
 - ▶ Latency is the sum of each step processing and data transmission time
- ▶ Each trigger processor **concurrently** processes many events
 - ▶ Divide the processing in steps, each performed within one BC

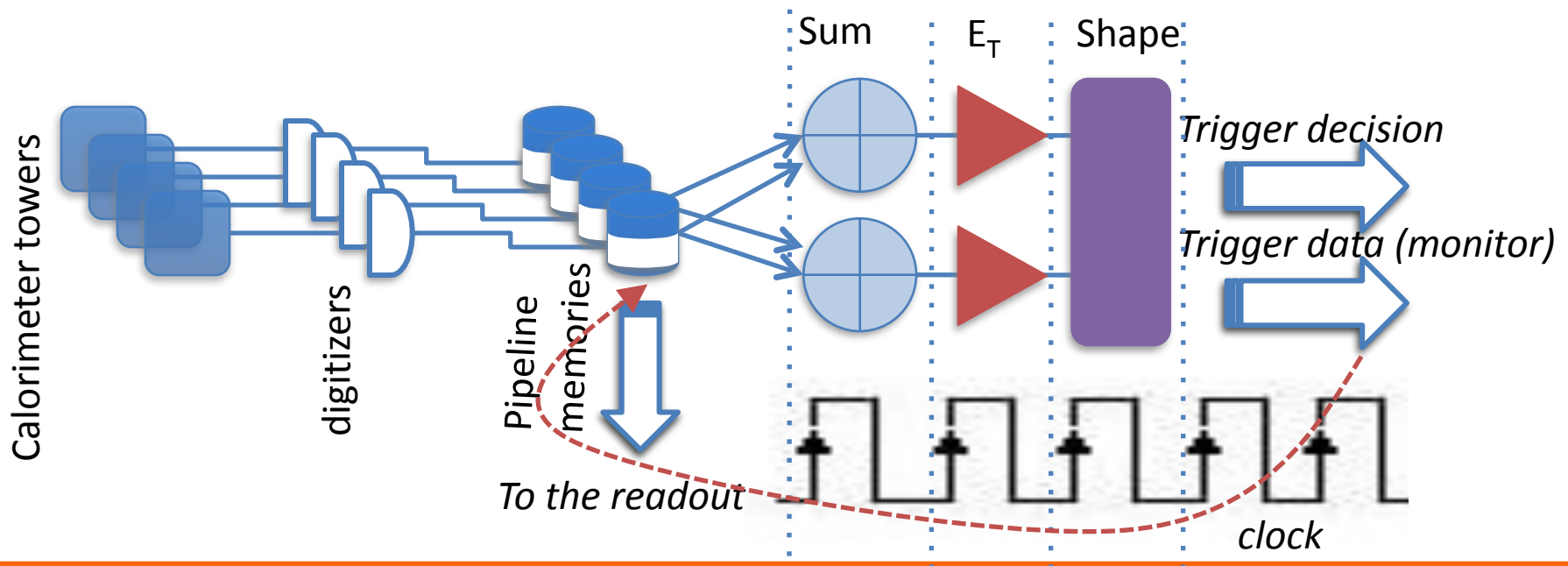

Choose your L1 trigger system

▶ Modular electronics

- ▶ Simple algorithms
- ▶ Low-cost
- ▶ Intuitive and fast use

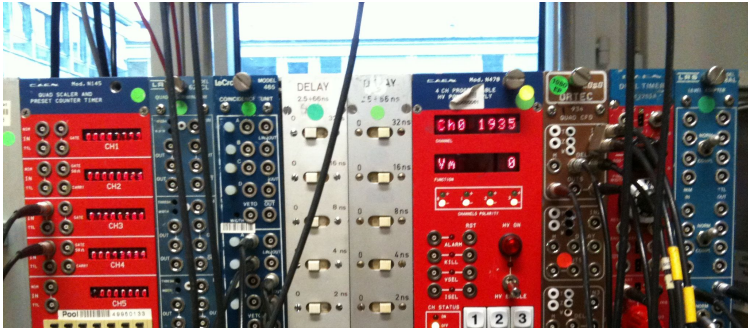

▶ Digital integrated systems

- ▶ Highly complex algorithms
- ▶ Fast signals processing
- ▶ Specific knowledge of digital systems

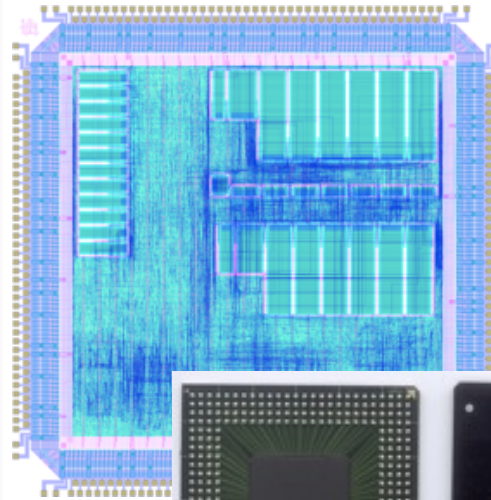

Level-1 trigger processors

Requirements at high trigger rates

- ▶ Fast processing
- ▶ Flexible/programmable algorithms
- ▶ Data compression and formatting
- ▶ Monitor and automatic fault detection

Digital integrated circuits (IC)

- ▶ Reliability, reduced power usage, reduced board size and better performance

Different families on the market:

▶ Microprocessors (CPUs, GPGPUs, ARMs, DSP=digital signal processors..)

- ▶ Available on the market or specific, programmed only once

▶ Programmable logic devices (FPGAs, CAMs,...)

- ▶ More operations/clock cycle, but costly and difficult software developing

▶ **New trend is the integration of both:**

- ▶ Using standard interface (ethernet), can profit of standard software tools (like for Linux or real-time) and development time is reduced

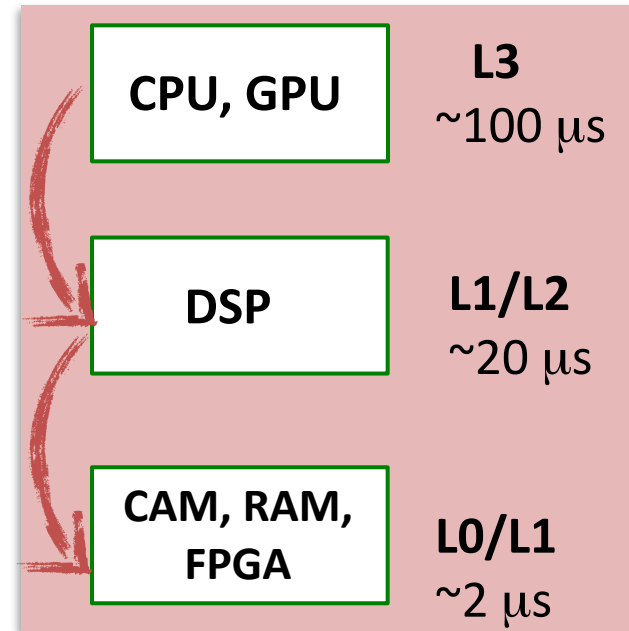

need instructions

already learned the task

Data movement technologies

- ▶ Faster data processing are placed on-detector (close or joined to the FE)
- ▶ Intermediate crates are **good separation** between FE (long duration) and PCs

On-detector

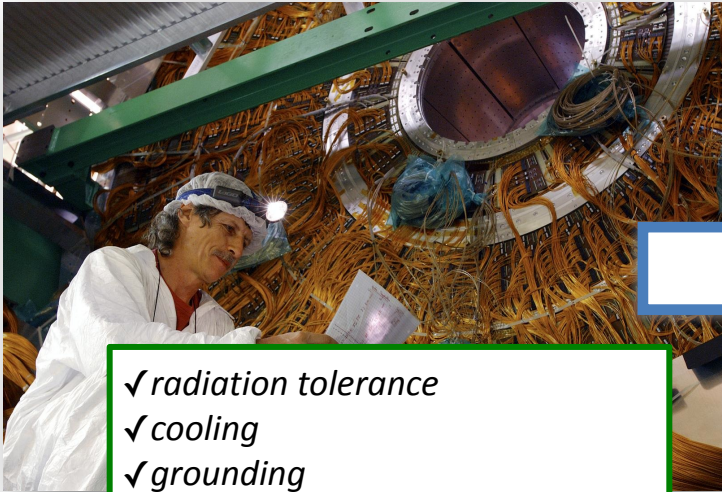

- ✓ radiation tolerance
- ✓ cooling
- ✓ grounding
- ✓ operation in magnetic field
- ✓ very restricted access

Off-detector

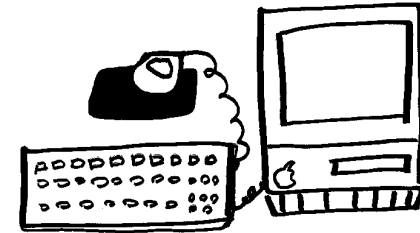

- ▶ **High-speed** serial links, electrical and optical, over a variety of distances
 - ▶ Low cost and low-power LVDS links, @400 Mbit/s (up to 10 m)
 - ▶ Optical GHz-links for longer distances (up to 100 m)
- ▶ **High density** backplanes for data exchanges within crates
 - ▶ High pin count, with point-to-point connections up to 160 Mbit/s
 - ▶ Large boards preferred

Multiple signatures: the ATLAS calorimeter trigger

► Identify high energy $e, \gamma, \tau, \text{jets}, \text{missing } E_T, \Sigma E_T$

► 1: Dedicated Front-End electronics

► Front-End of cells sends shaped analog signals

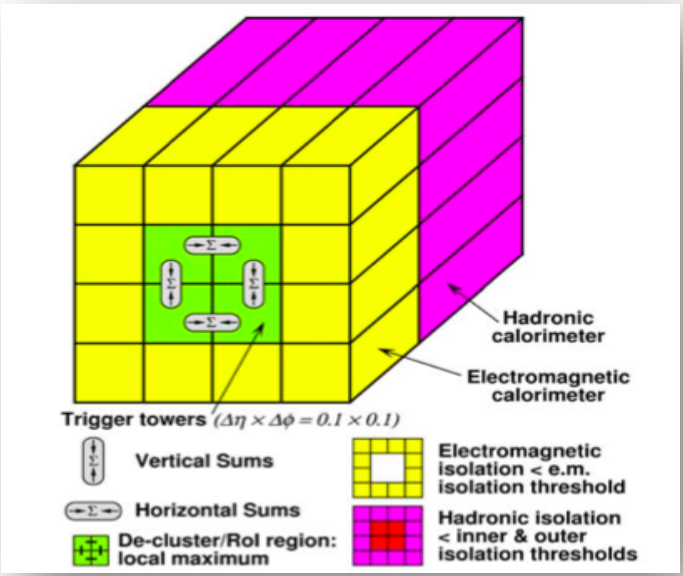
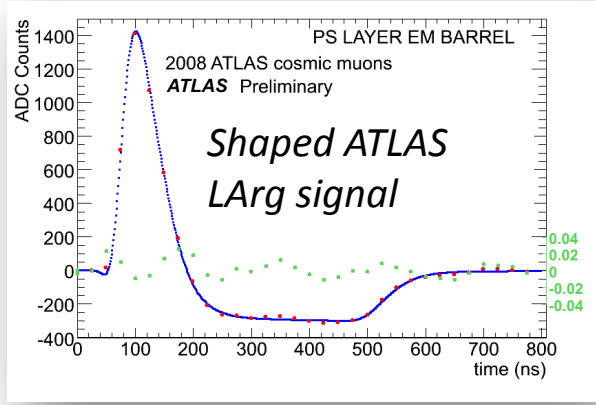
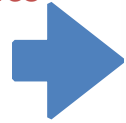

► 2: Level-1 trigger

► Dedicated processors apply simple cluster algorithms over cells and programmable E_T thresholds

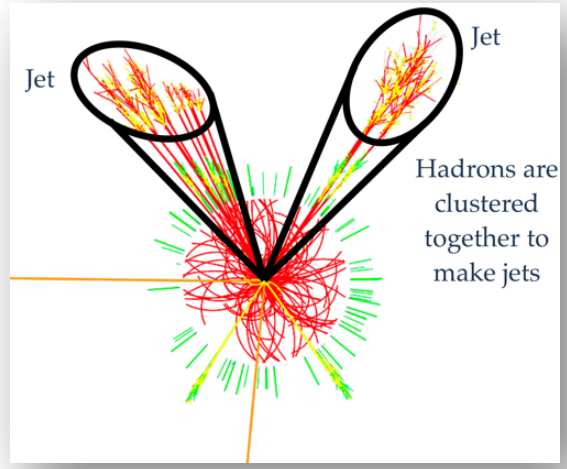

► 3: High-Level triggers

- electron/jet separation using
 - Cluster shapes
 - Topological variables and tracking information
 - Isolation criteria

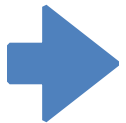

Example : ATLAS calorimeter trigger

- ▶ L1 trigger and digitisation is off-detector
- ▶ Pre-processor board
 - ▶ ASICs to perform the trigger algorithm
 - ▶ Assign energy (ET) via Look-Up tables
 - ▶ Apply threshold on ET
 - ▶ Peak-finder algorithm to assign the BC

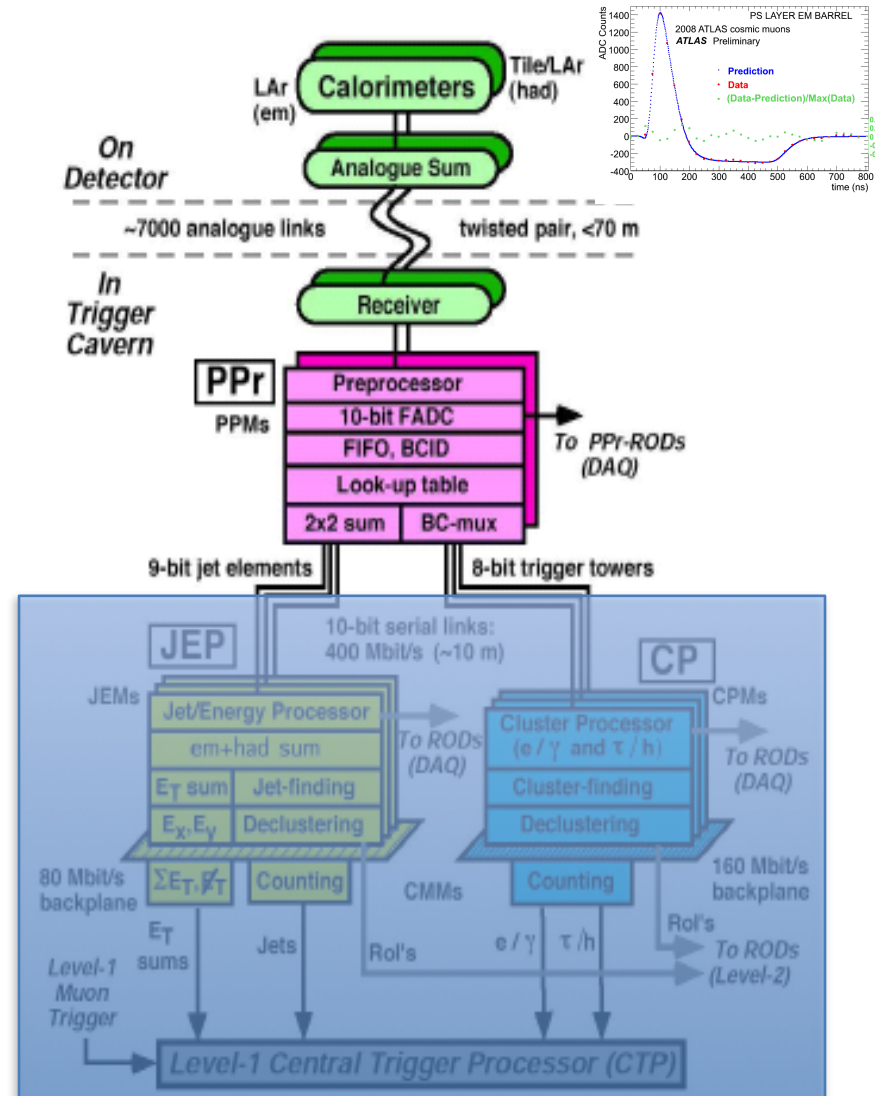
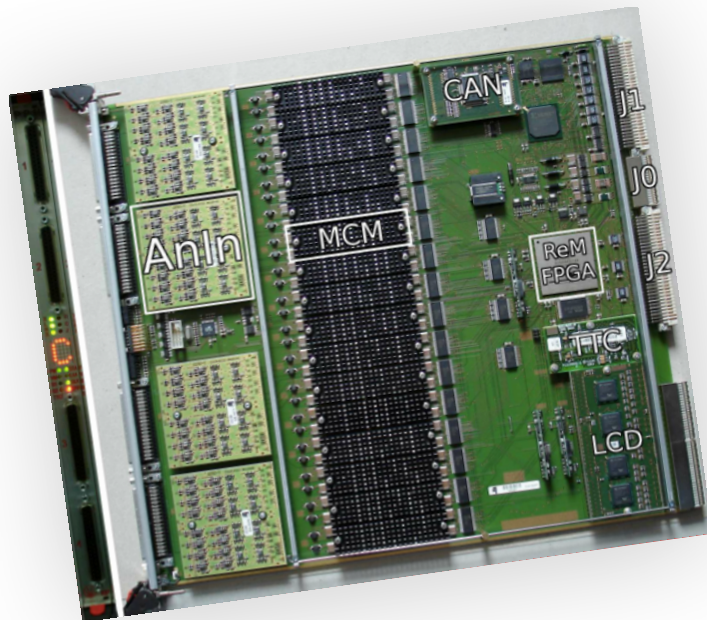

Example: ATLAS calorimeter trigger

- ▶ Cluster Processor (CP)
- ▶ Jet/Energy Processor (JEP)
- ▶ Implemented in programmable FPGAs
- ▶ Total of 5000 digital links connect PPr to JEP and CP, 400 Mb/s

Clustering in ATLAS e/γ trigger algorithm

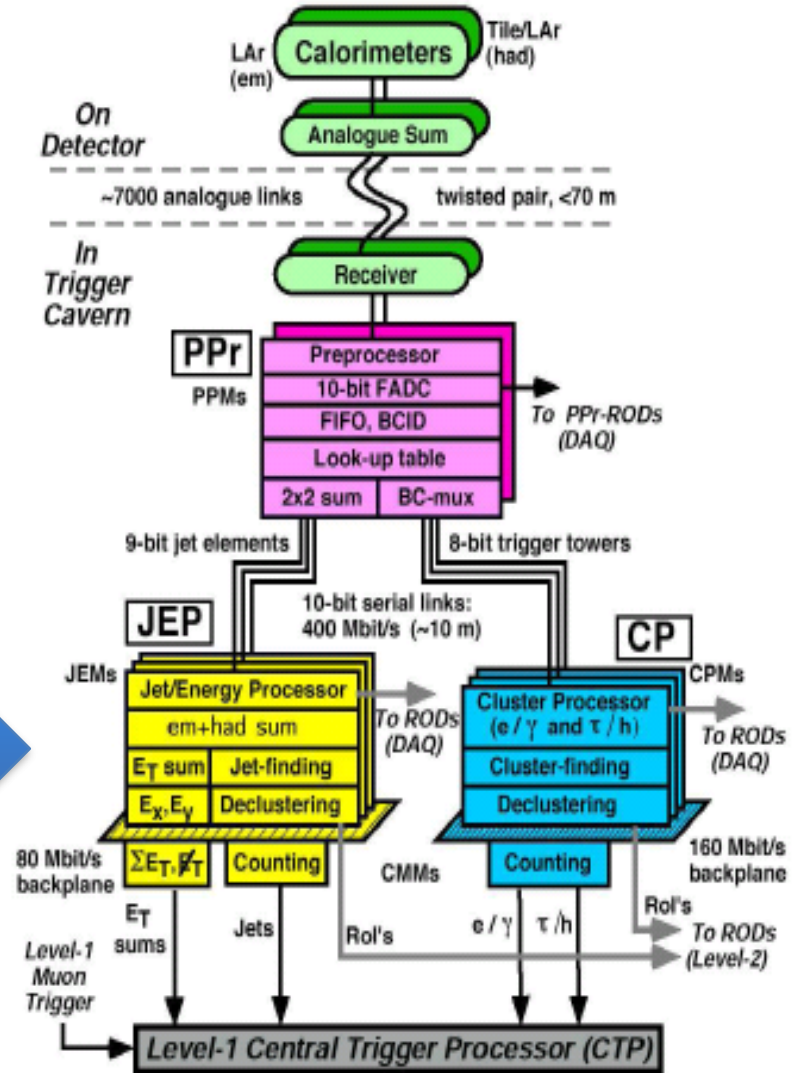
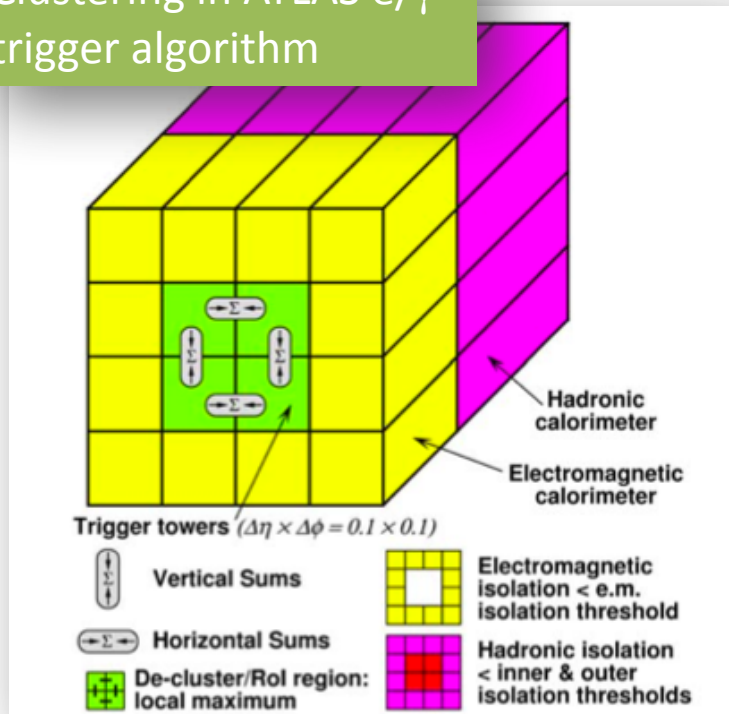

High level triggers



High Level Trigger Architecture

- ▶ After the L1 selection, data rates are reduced, **but can be still massive**

	Levels	L1 rate (Hz)	Event size	Readout bandw.	Data filter out
LEP	2/3	1 kHz	100 kB	few 100 kB/s	~5 Hz
ATLAS	2/3	100 kHz (L2: 10 kHz)	1.5 MB	30 GB/s (incremental Event Building)	~200 Hz
CMS	2	100 kHz	1.5 MB	100 GB/s	~200 Hz

- ▶ LEP: 40 MB/s VME bus was able to support the bandwidth
- ▶ LHC: use **latest technologies** in processing power, high-speed network interfaces, optical data transmission
- ▶ High data rates are held with different approaches
 - ▶ Network-based event building (LHC example: CMS)
 - ▶ Seeded reconstruction of partial data (LHC example: ATLAS)

Can we use the offline algorithms online?

MDDAG, Benbouzid, Kegl et al.

Multivariate analysis?

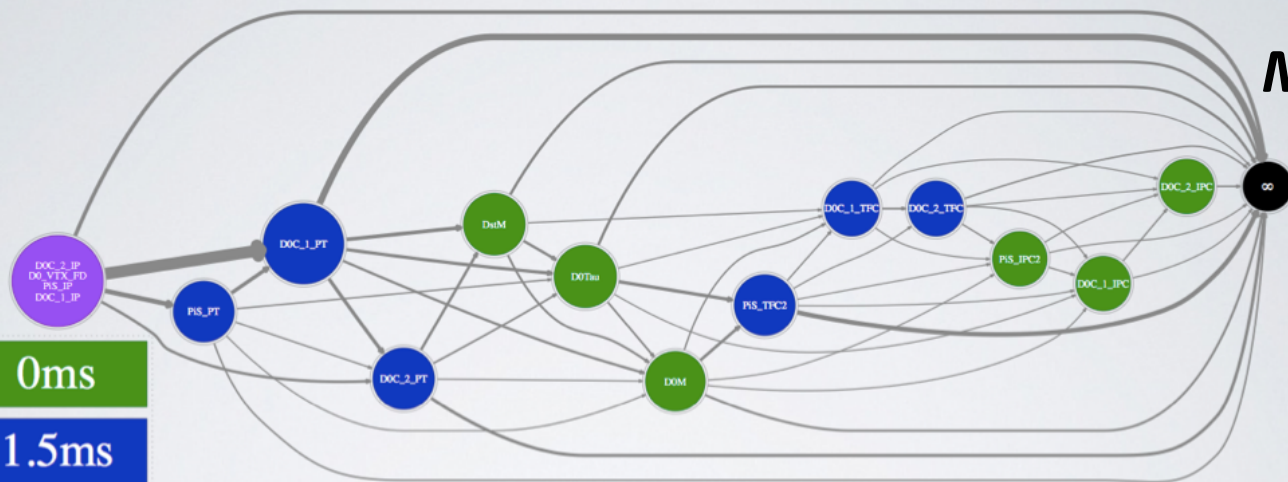

Pattern recognition in dense environment?

Latency is the constraint!

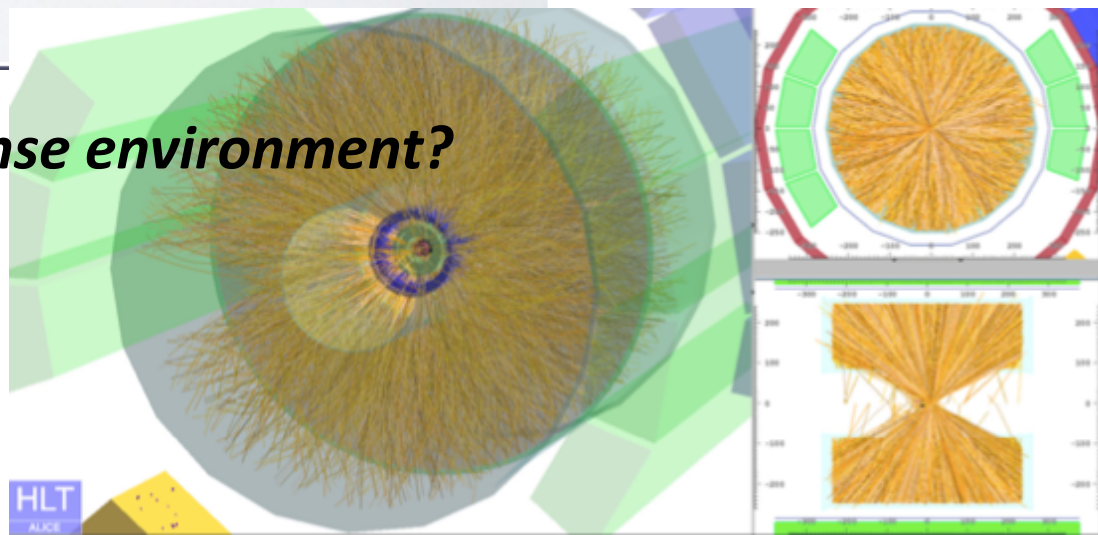

HLT design principles

- ▶ **Early rejection: alternate steps of feature extraction with hypothesis testing**
 - ▶ Reduce data and resources (CPU, memory....)
- ▶ **Event-level parallelism**
 - ▶ Process more events in parallel, with multiple processors
 - ▶ Multi-processing or/and multi-threading
- ▶ **Algorithm-level parallelism**
 - ▶ Need to change paradigms for software developments
 - ▶ **GPUs** can help in cases where large amount of data can be processed concurrently

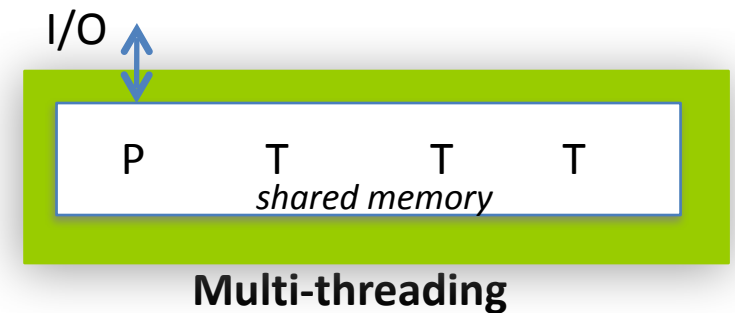
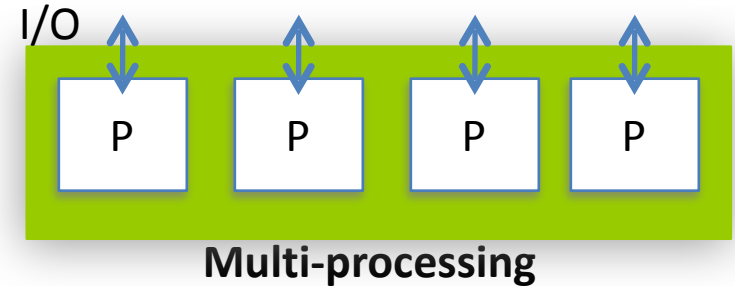
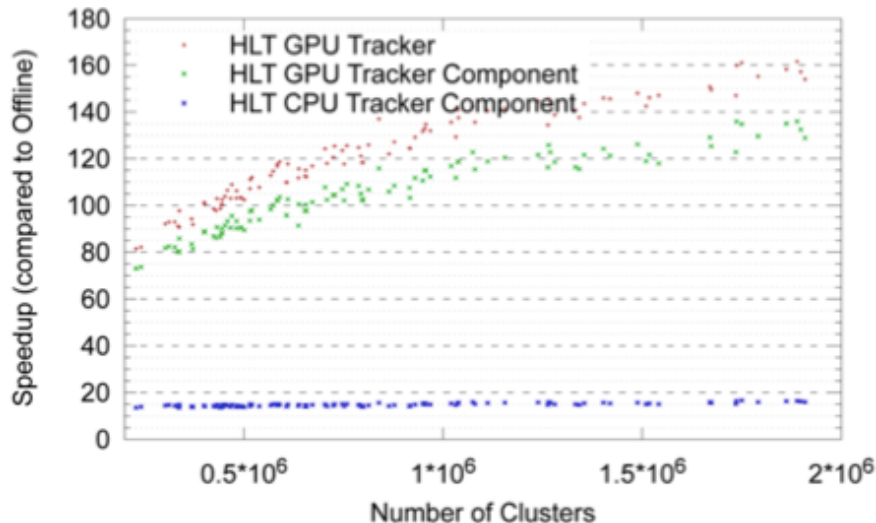

Algorithms are developed and optimized offline

Try to have common software with offline reconstruction, for easy maintenance and higher efficiency

Concluding remarks

- ▶ The trigger strategy is a trade-off between physics requirements and affordable systems and technologies
 - ▶ A good design is crucial – then the work to maintain optimal performance is easy
- ▶ Here we just reviewed the main trigger requirements coming from physics
 - ▶ High efficiency – rate control
 - ▶ Perfect knowledge of the trigger selection on signal and background
 - ▶ Flexibility and redundancy
- ▶ Microelectronics, networking, computing expertise are required to build an efficient trigger system
 - ▶ But being always in close contact with the physics measurements we want to study

Back-up slides

Trigger efficiency measurement (3)

$$\text{Efficiency} = \frac{\text{number of events that passed the selection}}{\text{number of events without that selection}}$$

- ▶ Experimental technique called “**Tag-and-Probe**” can be applied on some specific signatures (for example electrons, muons,...)
 - ▶ Use a **known physics process** in which the signature can be selected very clean (like the Z-boson decay into leptons)
 - ▶ Ensures that we are excluding fakes
- ▶ How?
 - ▶ Online: Trigger on independent signature (**Tag**)
 - ▶ Offline: Reconstruct the event and identify the candidate signature (**Probe**)
 - ▶ For example, tight offline requirements and Z mass selection
 - ▶ Offline: measure trigger efficiency on the Probe

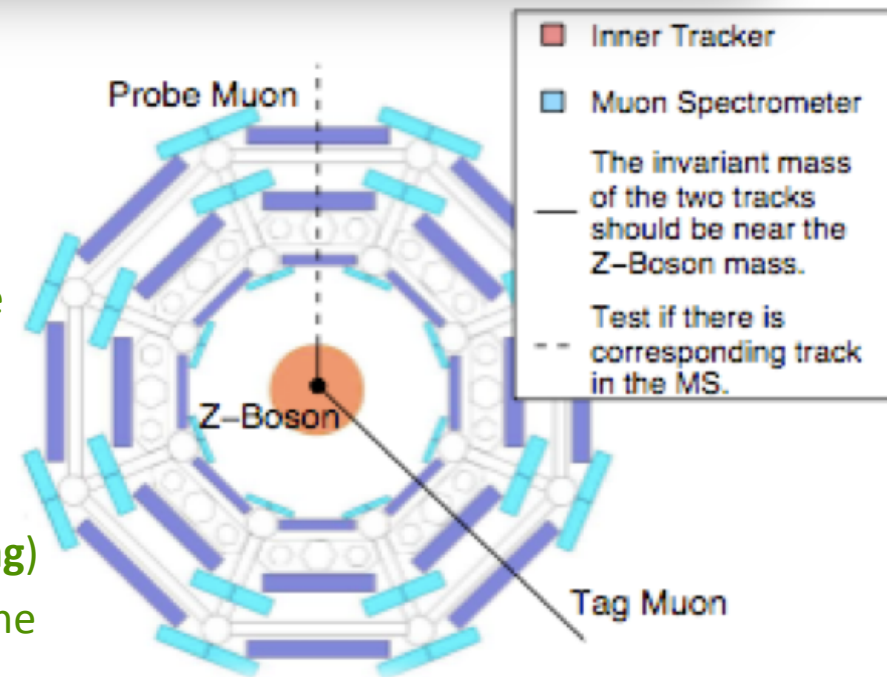

Use back-up triggers:
L1_LOWEST_THRESHOLD

Custom trigger processors?

- ▶ Application-specific integrated circuits (**ASICs**): optimized for fast processing (Standard Cells, full custom)
 - ▶ Intel processors, ~ GHz
- ▶ Programmable ASICs (like Field-programmable gate arrays, **FPGAs**)
 - ▶ Easily find processors @ 100 MHz on the market (1/10 speed of full custom ASICs)

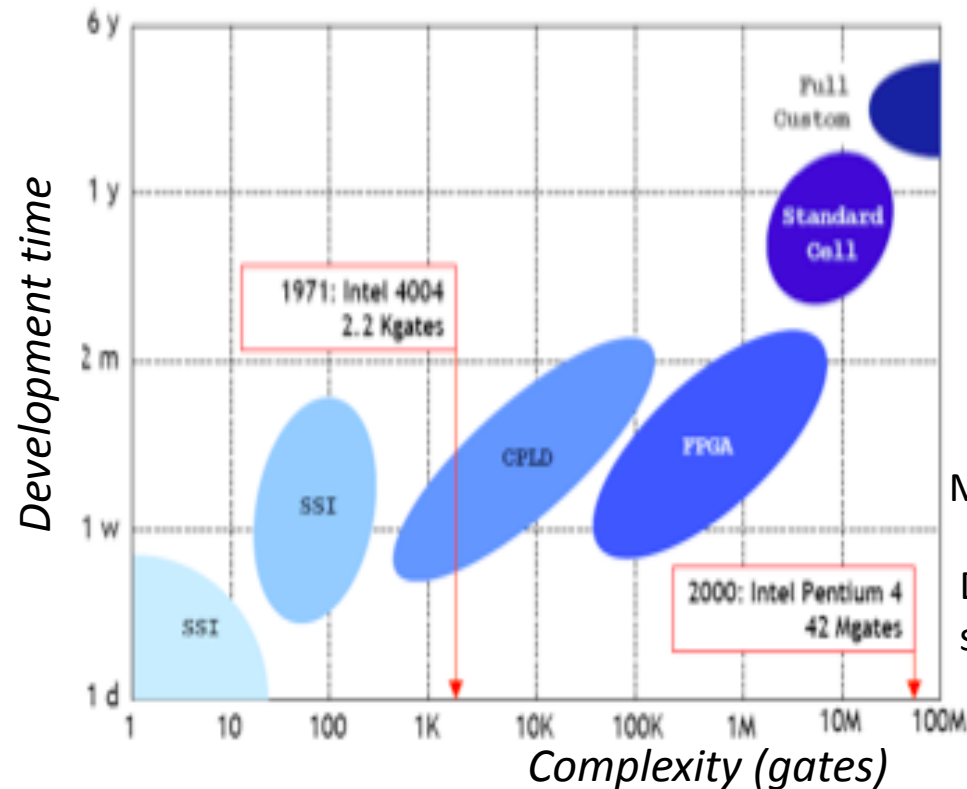

I/O PADs

Microcells (RAM)

Digital logic with standard cells

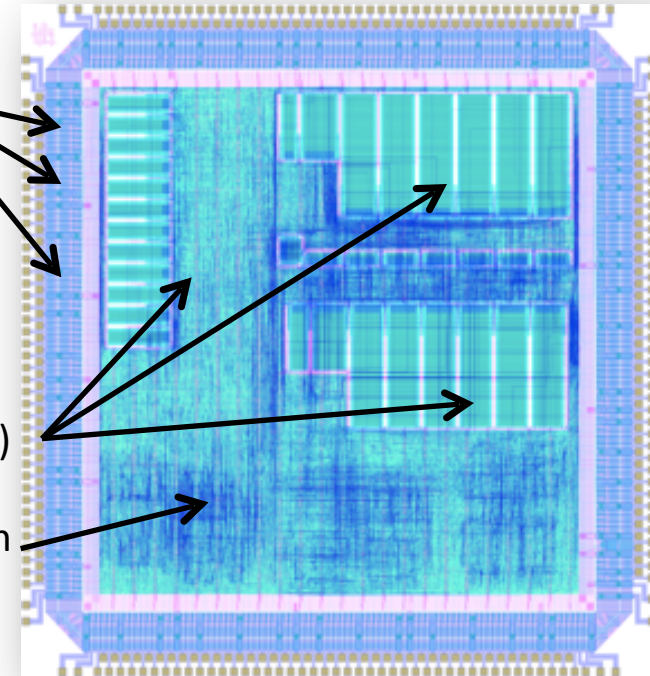

Layout of the CM ASIC

Example: logic of a trigger ASIC

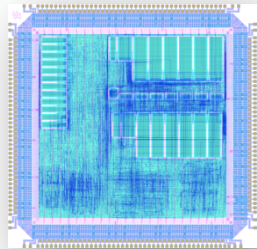

Digital inputs
from
detector

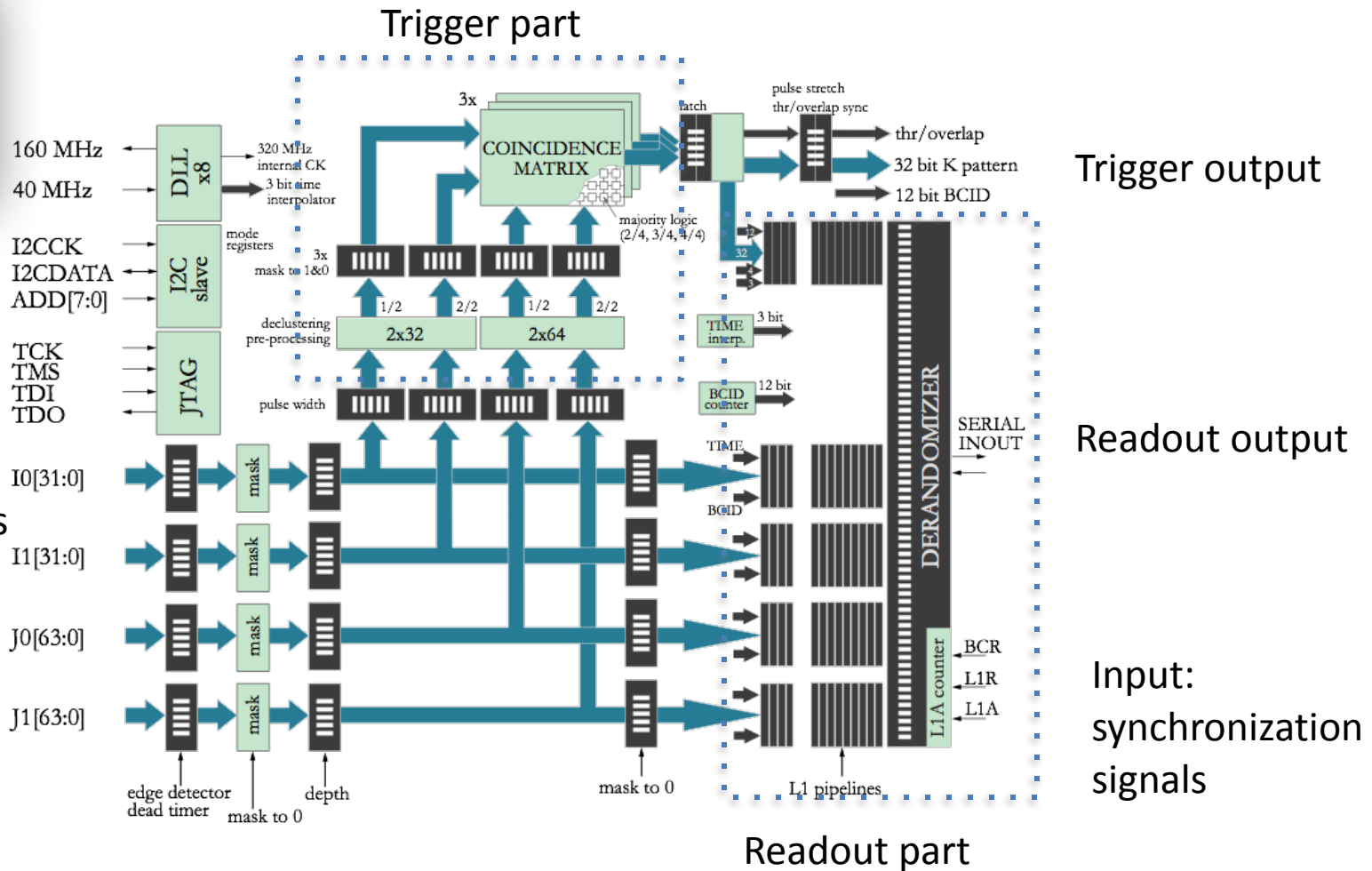

Coincidence Matrix ASIC for Muon Trigger in the Barrel of ATLAS

Standardizing Ethernet Speeds

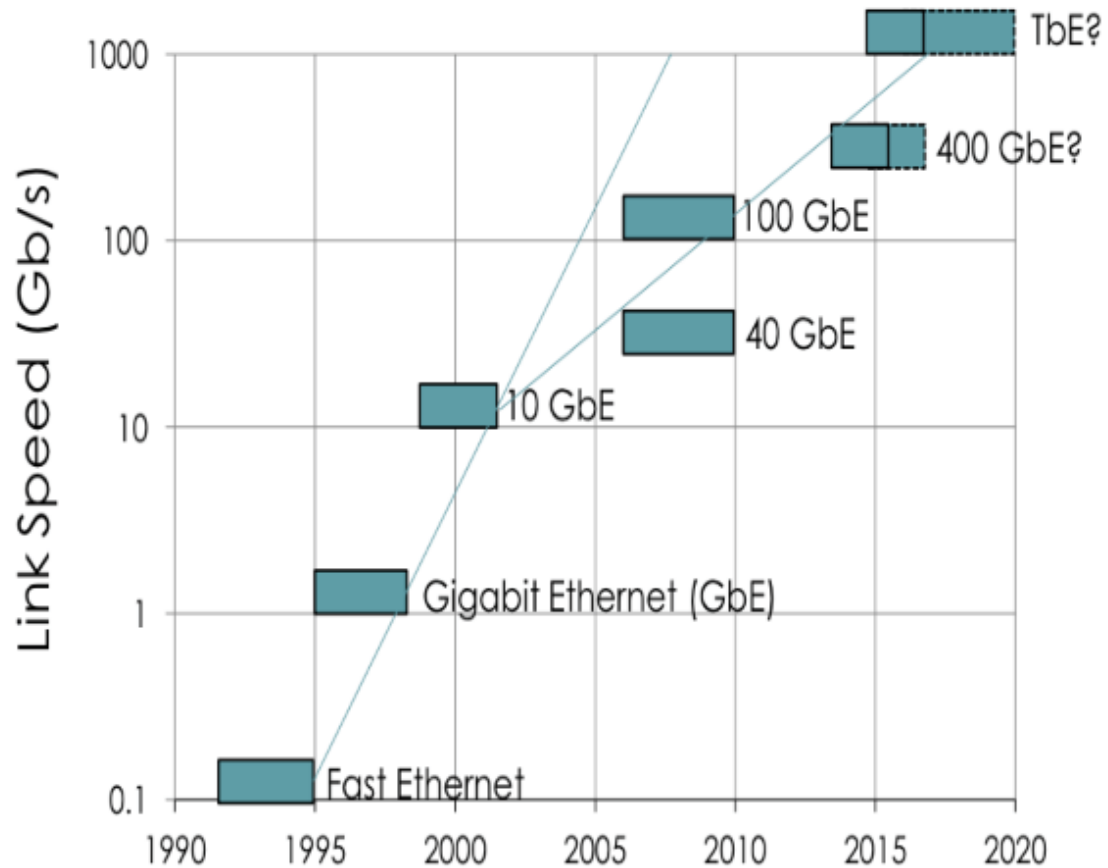

The 38th TOP500 List as of November 2011

Performance Development

